

---

# Pro-Motion User's Guide



Performance Motion Devices, Inc.  
55 Old Bedford Road  
Lincoln, MA 01773

Revision 1.1, July 2006



## **NOTICE**

This document contains proprietary and confidential information of Performance Motion Devices, Inc., and is protected by federal copyright law. The contents of this document may not be disclosed to third parties, translated, copied, or duplicated in any form, in whole or in part, without the express written permission of PMD.

The information contained in this document is subject to change without notice. No part of this document may be reproduced or transmitted in any form, by any means, electronic or mechanical, for any purpose, without the express written permission of PMD.

Copyright 1998–2006 by Performance Motion Devices, Inc.

Magellan, ION, Magellan/ION, Pro-Motion, C-Motion, and VB-Motion are trademarks of Performance Motion Devices, Inc.

---

## **Warranty**

PMD warrants performance of its products to the specifications applicable at the time of sale in accordance with PMD's standard warranty. Testing and other quality control techniques are utilized to the extent PMD deems necessary to support this warranty. Specific testing of all parameters of each device is not necessarily performed, except those mandated by government requirements.

Performance Motion Devices, Inc. (PMD) reserves the right to make changes to its products or to discontinue any product or service without notice, and advises customers to obtain the latest version of relevant information to verify, before placing orders, that information being relied on is current and complete. All products are sold subject to the terms and conditions of sale supplied at the time of order acknowledgement, including those pertaining to warranty, patent infringement, and limitation of liability.

## **Safety Notice**

Certain applications using semiconductor products may involve potential risks of death, personal injury, or severe property or environmental damage. These products are not designed, authorized, or warranted to be suitable for use in life support devices or systems or other critical applications. Inclusion of PMD products in such applications is understood to be fully at the customer's risk.

In order to minimize risks associated with the customer's applications, adequate design and operating safeguards must be provided by the customer to minimize inherent procedural hazards.

## **Disclaimer**

PMD assumes no liability for applications assistance or customer product design. PMD does not warrant or represent that any license, either express or implied, is granted under any patent right, copyright, mask work right, or other intellectual property right of PMD covering or relating to any combination, machine, or process in which such products or services might be or are used. PMD's publication of information regarding any third party's products or services does not constitute PMD's approval, warranty, or endorsement thereof.

---

## **Related Documents**

### **Magellan Motion Processor User's Guide**

Complete description of the Magellan Motion Processor features and functions with detailed theory of its operation.

### **Magellan Motion Processor Programmer's Command Reference**

Descriptions of all Magellan Motion Processor commands, with coding syntax and examples, listed alphabetically for quick reference.

### **Magellan Motion Processor Electrical Specifications**

Booklets containing physical and electrical characteristics, timing diagrams, pinouts, and pin descriptions of each series:

MC58000 Series, for DC brush, brushless DC, Microstepping, and Pulse & Direction motion processors

MC55000 Series, for Pulse & Direction motion processors

### **Magellan Motion Processor Developer's Kit Manual**

How to install and configure the DK58000 series and DK55000 series developer's kit PC board.

### **Magellan Motion Controller Card User's Guide**

How to install and configure the Magellan-PCI motion board.

### **ION Digital Drive User's Manual**

How to install and configure ION Digital Drives.

# Table of Contents

---

<b>1. Introduction</b>	<b>9</b>
1.1 Introduction to Pro-Motion	9
1.2 Pro-Motion Specifications	10
<b>2. Getting Started</b>	<b>13</b>
2.1 Getting Started with Pro-Motion	13
2.2 Installing Pro-Motion	13
2.3 Launching Pro-Motion	14
2.4 Running the Axis Wizard	16
<b>3. The Pro-Motion Interface</b>	<b>19</b>
3.1 Overview	19
3.2 The Pro-Motion Windows	20
3.3 Accessing Pro-Motion's Windows and Utilities	20
3.4 Pro-Motion View Options	23
3.5 Conventions and Hot Keys	24
3.6 Opening an Existing Project	25
3.7 Setting Module Properties	26
<b>4. Control Window</b>	<b>29</b>
4.1 Overview of the Control Window	29
4.2 Motor Type	31
4.3 Trajectory Module	32
4.4 Position Loop Module (Servo Motors Only)	35
4.5 Motor Control Module	39
4.6 Current Loop Module	41
4.7 Phasing Module	42
4.8 Motor Output Module	46
4.9 Feedback Module	48
4.10 Operating Mode Module	49
4.11 Tracking Module	50
4.12 Limit Switches Module	52
4.13 Breakpoints Module	53
4.14 Axis I/O Module	56
4.15 Event Manager Module	57
4.16 Units Module	58

<b>5. Monitoring Motion</b>	<b>61</b>
5.1 Introduction	61
5.2 The Scope (Oscilloscope) Window	61
5.3 The Status Window	68
5.4 The Drive Status Window (ION Only)	69
<b>6. The Axis Wizard</b>	<b>71</b>
6.1 Introduction to the Axis Wizard	71
6.2 Encoder Setup	71
6.3 Microstepping Motor Settings	73
6.4 Motor Output Test	74
6.5 Servo Loop Tuning (Servo Motors Only)	79
6.6 Encoder Index Signal Test	83
6.7 Positive/Negative Limit Switch Tests	85
7.1 The Command Window	87
<b>7. Command Processing</b>	<b>87</b>
7.1 The Command Window	87
7.2 The Monitor Window	90

# List of Figures

---

2-1	Interface dialog box	14
2-2	Serial port dialog box	15
2-3	CAN port dialog box	15
2-4	Project window	16
2-5	Axis Wizard opening page	17
3-1	Pro-Motion interface: normal view	19
3-2	Tuning view	24
3-3	Project window	25
3-4	Upload caution message	26
3-5	Setting module properties	26
4-1	Control window	29
4-2	Trajectory dialog box	32
4-3	Position Loop dialog box	35
4-4	Filter Coefficients dialog box	37
4-5	Tuning view	38
4-6	Motor Control dialog box (brushless DC and DC brush motors)	39
4-7	Current Loop dialog box	42
4-8	Phasing dialog box	43
4-9	Motor Output dialog box (ION only)	47
4-10	Motor Output dialog box (Magellan only)	47
4-11	Feedback dialog box	48
4-12	Operating Mode dialog box	49
4-13	Tracking dialog box	50
4-14	Limit Switches dialog box	52
4-15	Breakpoints dialog box	54
4-16	Axis I/O dialog box	56
4-17	Event Manager dialog box	57
4-18	Units dialog box	58
5-1	Scope window	62
5-2	Scope Settings dialog box	63
5-3	Exported trace data	67
5-4	Status window	68
5-5	Drive Status window (ION only)	69
6-1	Encoder test	72
6-2	Microstepping motor settings	73
6-3	Motor output test	74
6-4	Algorithmic phase initialization method (brushless DC only)	75
6-5	Hall signal test (brushless DC only)	76
6-6	Commutation test (brushless DC only)	77



---

## List of Figures

6-7	Current loop tuning (ION only) . . . . .	78
6-8	Servo loop tuning . . . . .	80
6-9	Encoder Index signal test . . . . .	83
6-10	Capture Input signal test . . . . .	84
6-11	Positive Limit switch signal test . . . . .	85
7-1	Command window . . . . .	87
7-2	Sample command session . . . . .	88
7-3	Sample monitor view . . . . .	90



## *In This Chapter*

- ▶ Introduction to Pro-Motion
- ▶ Pro-Motion Specifications

## 1.1 Introduction to Pro-Motion

Pro-Motion is a prototyping tool designed to expedite the development of your Magellan Motion Processor-based system. It is a sophisticated, easy-to-use program that uses a standard Windows interface. Pro-Motion optimizes motion system development by facilitating the setting and viewing of all parameters and the exercising of all features of your Magellan-based product.

### 1.1.1 Pro-Motion Features

Pro-Motion can be used as a:

- Ready-to-go motion exerciser that can be used by the entire development team.
- Analysis tool for optimizing profiles and servo parameters.
- Pre-production system for verifying amplifier, motor, and hardware performance.
- Software-development system for prototyping Magellan command sequences.

Pro-Motion allows you to:

- Access motion control features easily using graphical icons and buttons.
- Create and save separate motion projects, and re-load the current settings of each.
- Configure hardware bus, serial, and CANbus connections to one or more Magellan-based cards or modules.
- Quickly configure motor type and other control parameters for each axis using the Axis Wizard.
- Auto-tune servo loop and current loop parameters.
- Perform a variety of motion trajectories as well as simple repetitive motions for testing and hardware burn-in.
- Try out new values for a processor and monitor the results to assess the effects of the changes.

- Monitor the action on an oscilloscope, then print or export the trace.
- Enter direct text commands at the command prompt
- Monitor the commands sent to the chip by your selected settings for further analysis before writing any code.

### 1.1.2 Products Supported by Pro-Motion

Pro-Motion supports PMD's Magellan-based products, including developer's kits, motion cards, and ION digital drives, as shown in the following table.

Product No.	Description
<b>Developer's kits</b>	
DK58000	Developer's Kit for MC58000 Magellan Motion Processor
DK55000	Developer's Kit for MC55000 Magellan Motion Processor
<b>Cards</b>	
MB9058000	PCI-based motion card with support for all motor types
MB9055000	PCI-based motion card with support for Pulse & Direction motors
<b>ION modules</b>	
Dx131x0	ION Digital Drive module for brushless DC motors
Dx111x0	ION Digital Drive module for DC brush motors
Dx141x0	ION Digital Drive module for step motors

**NOTE:** *Pro-Motion does not support Navigator products.*

For a complete list of Magellan products, refer to Chapter 1 in the *Magellan Motion Processor User's Guide*.

## 1.2 Pro-Motion Specifications

### 1.2.1 Software and User's Guide

Pro-Motion software plus a copy of this User's Guide are provided on the installation CD.

## 1.2.2 Hardware and Software Requirements

The following platform is required to run Pro-Motion:

- Intel (or compatible) processor, Pentium or better.
- 20MB of available disk space.
- 16MB of available RAM.
- PC operating system: Windows 98/ME/NT/2000/XP.

**NOTE:** *Pro-Motion is for use on a system where a Magellan product has been installed.*

For more information about hardware and software requirements, refer to the *Magellan Motion Processor Developer's Kit Manual*.

*This page intentionally left blank.*

## *In This Chapter*

- ▶ Getting Started with Pro-Motion
- ▶ Installing Pro-Motion
- ▶ Launching Pro-Motion
- ▶ Running the Axis Wizard

## 2.1 Getting Started with Pro-Motion

**NOTE:** Before you can install Pro-Motion, you must have installed your Magellan-based hardware product. (For instructions for installing Magellan-based products, refer to the appropriate user's manual for your product.)

The three stages of the process for getting started in Pro-Motion are described here. Instructions for each stage follow in this chapter.

- 1 Install the Pro-Motion software (Section 2.2).
- 2 Launch Pro-Motion and establish communication with the Magellan-based product (Section 2.3).
- 3 Run the Axis Wizard to set up your project parameters (Section 2.4). Using the Wizard you will:
  - Select the type of motor that will be connected to the axis (Magellan only).
  - Set up, test, and adjust (if necessary) the appropriate Encoder Type.
  - Set up motor output signal type that is compatible with your amplifier, and the necessary frequency, mode, and/or range settings for the selected motor output signal type; test, and adjust the settings.
  - Set up and test a method for initializing commutation (brushless DC only).
  - Enter the Servo setup and position capture signal and test the Encoder index or Home signal, as applicable.
  - Test Positive and Negative limit switches.

## 2.2 Installing Pro-Motion

To install Pro-Motion, insert the Pro-Motion installation CDROM in your system's CD drive. If you have autorun enabled, the installation program will start when you insert the CDROM and guide you through the process, which will install the Pro-Motion software and a pdf version of the *Pro-Motion User's Guide*.

Once the software is installed, the Pro-Motion icon will appear on your desktop:



**NOTE:** *The Adobe Acrobat Viewer is required for viewing the User Guide files. If the viewer is not installed on your computer, you can download it from <http://www.adobe.com>.*

## 2.3 Launching Pro-Motion

To launch Pro-Motion:

- 1 Click on the Pro-Motion icon on the desktop. Pro-Motion will attempt to connect to your Magellan-based product using the default settings
  - If the connection is made, Pro-Motion's Normal View is displayed (Figure 3-1), and Pro-Motion is ready for use.
  - If Pro-Motion does not automatically establish communication with the Magellan-based product the Interface dialog box (Figure 2-1) is displayed.
- 2 Select the appropriate interface type.

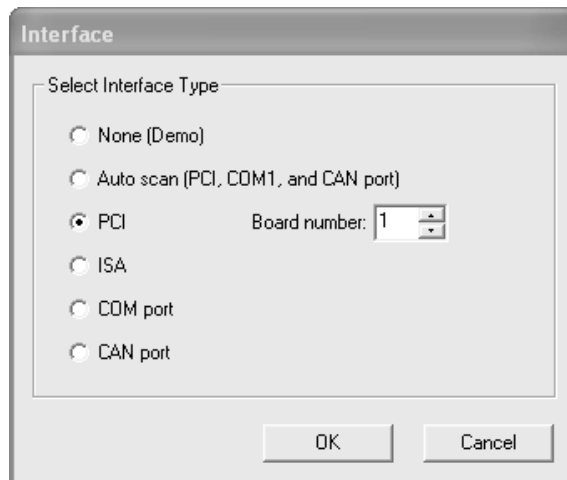

**Figure 2-1:**  
Interface  
dialog box

- If you are using the serial interface, select the appropriate COM port number. Click OK to display the Serial port dialog box (Figure 2-2), then complete the fields in that dialog box.

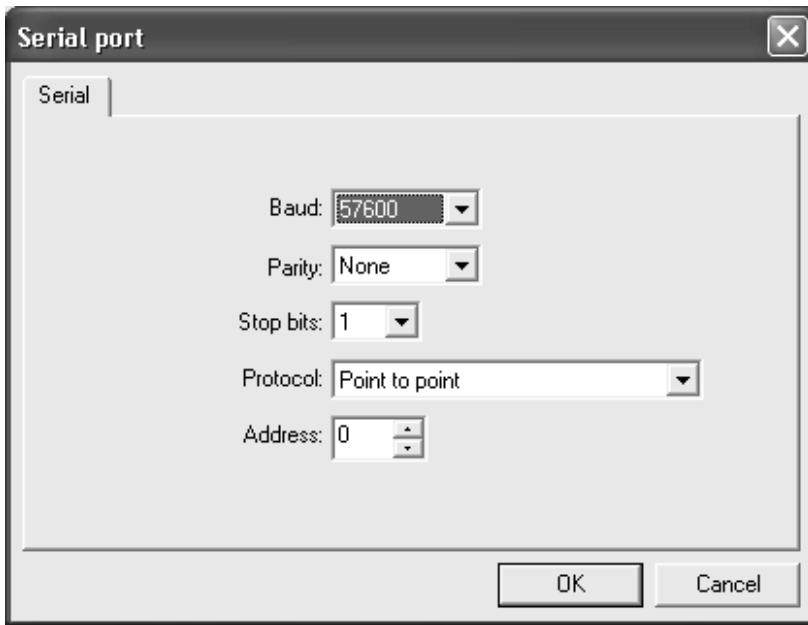

---

**Figure 2-2:**  
Serial port  
dialog box

---

- If you are using a CAN interface, select CAN port and click OK. The CAN port dialog box is displayed (Figure 2-3). Enter the appropriate Baud rate and Node ID, then click OK.

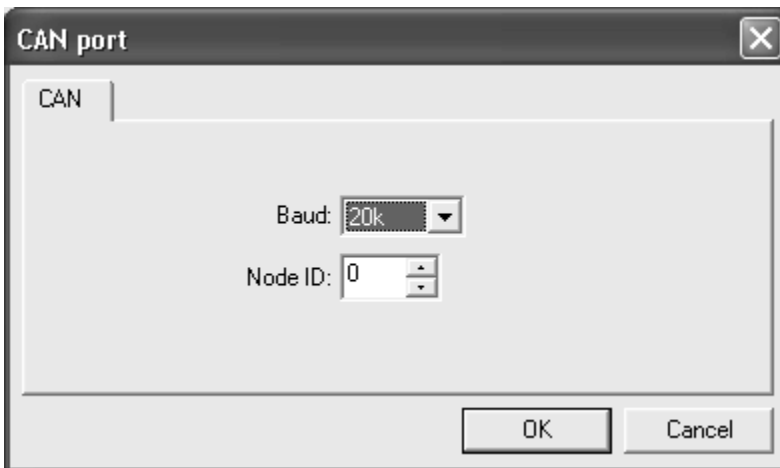

---

**Figure 2-3:**  
CAN port  
dialog box

---

- If you are using a PCI card, select PCI interface; the Board number field is displayed. Select the appropriate board number. If you have only one card, enter 1.
  - If Pro-Motion finds the motion board or ION module, it will make the connection and open in Normal View (Figure 3-1) with the model number of the connected motor and its axes displayed in the Project window.
  - If the connection fails, an error message is displayed. Click OK to return to the Interface dialog box and try again. If repeated attempts fail, contact PMD.
- 3 Continue by running the Axis Wizard (Section 2.4).

## 2.4 Running the Axis Wizard

Once you have established communication with the Magellan-based product, continue the setup by running the Axis Wizard. The Wizard will guide you through the process of making motor connections and setting and testing parameters for the selected axis.

The Axis Wizard is customized for each motor type (DC brush/brushless DC, micro-stepping, or pulse & direction).

### 2.4.1 To Run the Axis Wizard:

- 1 In the Project window (Figure 2-4), select the axis you want to set up.

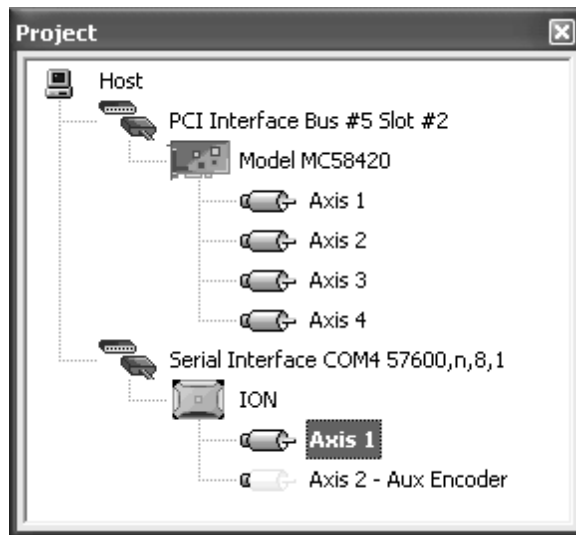

**Figure 2-4:**  
Project  
window



Select the Axis Wizard icon from the Pro-Motion tool bar (or View/Axis Wizard from the menu bar) to open the Axis Wizard (Figure 2-5). The Wizard will lead you through the setup for your motor. Note that as you perform the Axis Wizard tests, you will be able to return to previous Wizard pages to change settings if necessary. (For detailed information about the Axis Wizard, refer to Chapter 6.)



**Figure 2-5:**  
**Axis Wizard**  
**opening page**

***NOTE:** Once you have finished the Axis Wizard, you can use the options in the Control window to change settings and to set preferences for responses to events and units of measure.*

*This page intentionally left blank.*

# 3. The Pro-Motion Interface

## In This Chapter

- ▶ Overview
- ▶ The Pro-Motion Windows
- ▶ Accessing Pro-Motion's Windows and Utilities
- ▶ Pro-Motion View Options
- ▶ Conventions and Hot Keys
- ▶ Opening an Existing Project

## 3.1 Overview

The Pro-Motion interface consists of a set of dockable windows and dialog boxes that can be viewed individually within the Pro-Motion frame or floated on the desktop. Pro-Motion's options are accessed through these windows and dialog boxes and from menu selections and/or icons.

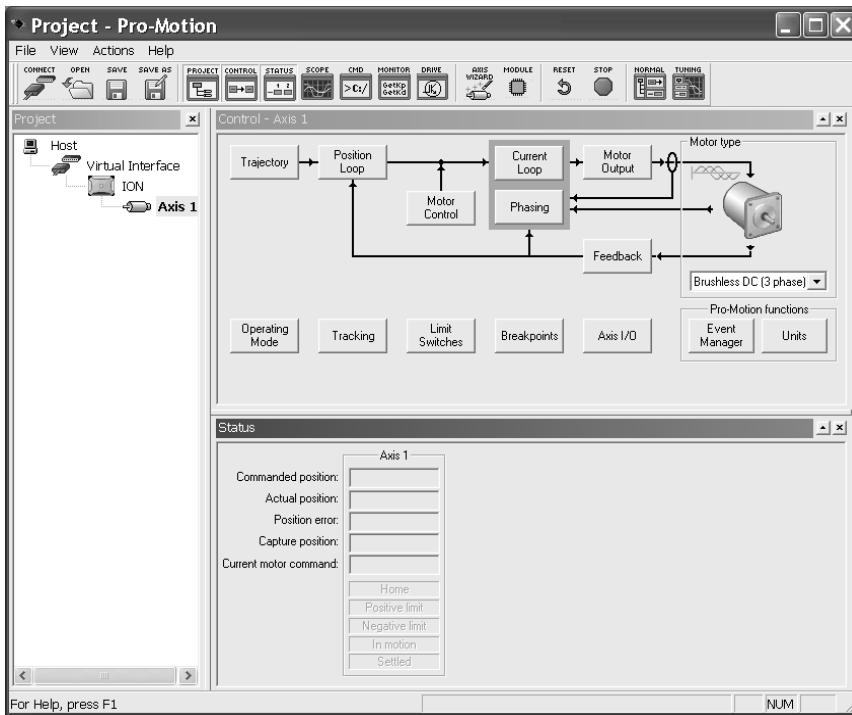

**Figure 3-1:**  
**Pro-Motion**  
**interface:**  
**normal view**

## 3.2 The Pro-Motion Windows

Pro-Motion has nine major windows. Each is described briefly in the following table, along with a reference to where in this manual you can find more detailed information about its function and use. Pro-Motion's windows are accessed by selecting the appropriate icon from the toolbar or the View menu on the menu bar.





Window	Use	For more information
Project	Shows the controllers Pro-Motion is connected to and their axes; used to select an active axis.	Section 3.6
Control	Used to manage motion processor functions (for example, setting trajectories and servo parameters, setting options for motion processor events, and so forth).	Chapter 4
Status	Shows position and signal data for up to four axes.	Section 5.4
Scope	Shows traces of motion processor data for up to four variables simultaneously.	Section 5.2
CMD	(Command) Used to issue commands directly to the motion processor, using a command line interface.	Section 7.1
Monitor	Shows the stream of commands currently being executed by an axis.	Section 7.2
Drive	(Drive Status) Shows the bus voltage and temperature of the current drive (ION only).	Section 5.4
Axis Wizard	Guides you through the process of setting up and testing motor connections and parameters for an axis.	Chapter 6
Module	Used to set global module properties (in contrast to setting axis-specific settings).	Section 3.7

## 3.3 Accessing Pro-Motion's Windows and Utilities

Pro-Motion's windows and utilities can be toggled open or closed by selecting the appropriate icon from the toolbar or its counterpart from View on the menu bar, as shown in the tables below. Pro-Motion also offers three standard combinations of windows: Normal view, Tuning view, and Custom view.



### 3.3.1 File Menu Options and Icons









The options available from icons on the toolbar or from the File menu on the menu bar are described in the tables below.

To...	Select...	Press...	Or click...
Connect Pro-Motion to a motion controller or processor	File/Connect	CTRL+C	
Display an existing project	File/Open Project	CTRL+O	
Save project parameters to a file	File/Save Project	CTRL+S	
Save an existing project file to a new file (Save as...)	File/Save Project As	N/A	
Open the previously opened project file	Revert	N/A	N/A
Export a trace on the oscilloscope	File/Export Trace	N/A	N/A
Display and execute a selected script in the Command window	File/Load Script	N/A	N/A
Print oscilloscope views/trace data, commands, etc.	File/Print	N/A	N/A

### 3.3.2 View Menu Options and Icons



The options available from icons on the toolbar or from the View menu on the menu bar are described in the tables below.

To...	Select...	Press...	Or click...
Display/close the Project window	View/Project	Alt+1	
Display/close the Control window	View/Control	Alt+2	

To...	Select...	Press...	Or click...
Display/close the Status window	View/Status	Alt+3	
Display/close the Scope window	View/Scope	Alt+4	
Display/close the Command window	View/Command	Alt+5	
Display/close the Monitor window	View Monitor	Alt+6	
Display/close the Drive Status window	View/Drive Status	Alt+7	
Display/close the Normal View	View/Normal View	N/A	
Display/close the Tuning View	View/Tuning View	N/A	
Custom View	View/Custom View	N/A	
Save as Custom View	View/Save As Custom View	N/A	
Open the Axis Wizard	View/Axis Wizard	CTRL+W	
Display the Module Properties dialog box	View/Module Properties	N/A	
Activate Status Polling to enable the event manager and Status window updates	View/Status Polling	N/A	N/A

### 3.3.3 Actions Menu Options and Icons

The options available from icons from the Actions menu on the menu bar and the icons from which they can also be accessed, are described in the following table.

To...	Select...	Or click...
Reset the motion processor to default settings	Action/Reset	
Stop all motors instantly by issuing an abrupt stop command and then disabling the motor output	Action/Emergency Stop (or press the hot key Pause/Break)	

## 3.4 Pro-Motion View Options

To toggle a window open or closed, select its icon from the toolbar or use the View menu. If open, the window will close. If closed, the window will open in the same location and dimensions as when it was last opened during the current session.

### 3.4.1 Standard Combination Views

Pro-Motion offers two standard combination views, each of which displays a set of windows and/or dialog boxes that are frequently utilized together:

- The Normal view (View/Normal View) contains the Project, Control, and Status windows (Figure 3-1). This is the default view when Pro-Motion is first opened.
- The Tuning view (View/Tuning View) displays the Scope window along with the floating Step Function and Position Loop dialog boxes (Figure 3-2).

### 3.4.2 Other View Options

Customize the current view by opening additional windows, which you can either float outside of the standard view or dock within the Pro-Motion frame. Save the current window layout as a Custom view, which can later be restored by selecting View/Custom View.

**Figure 3-2:  
Tuning view**

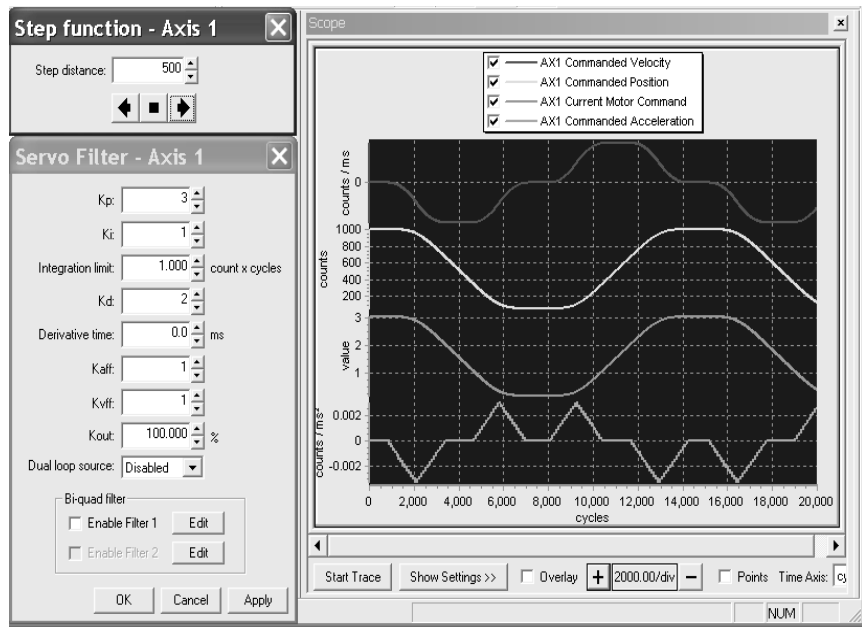

You can easily return to the standard Pro-Motion view by selecting the Normal icon from the toolbar (or View/Normal from the menu bar).

## 3.5 Conventions and Hot Keys

### 3.5.1 Pro-Motion Dialog Box Conventions

The following conventions are used in the Pro-Motion dialog boxes:

- Up/down arrows are provided for fields that require numerical data. (If you prefer, type in numerical data instead).
- Signal state symbols indicate whether a signal is off or on:
  - = Signal is off.
  - ⊙ = Signal is on.
- The Apply button is used to accept new or changed parameters and keep the dialog box open.
- The OK button is used to accept new/changed parameters and close the dialog box.



## 3.5.2 Pro-Motion Hot Keys

The following hot keys are available in Pro-Motion:

- To abruptly stop all axes and disable motor output, use the Pause/Break key.
- To pause the Output module, use the Scroll Lock key.
- To float a window on the desktop rather than docking it within the Pro-Motion frame, grab the window by its title bar and hold down the CTRL key as you move it.

## 3.6 Opening an Existing Project

### 3.6.1 The Project Window

The Project window (Figure 3-3) displays the model number and the axes of the motion controller to which Pro-Motion is connected. The window is used to select the axis that is to be currently active.

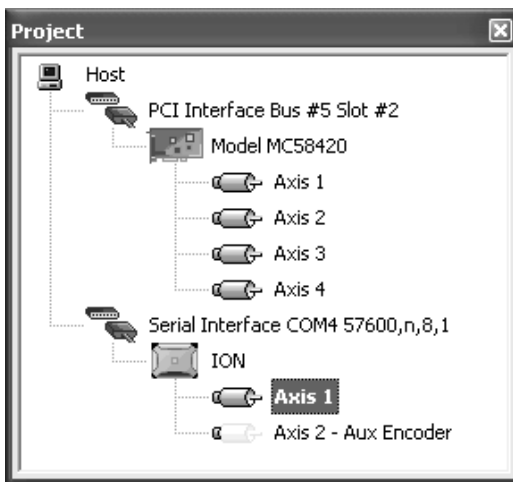
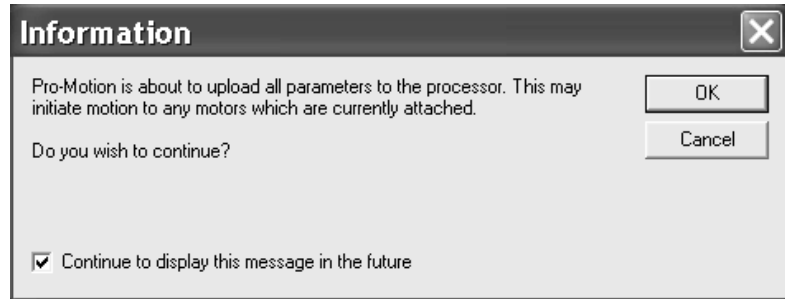

**Figure 3-3:**  
Project  
window

### 3.6.2 Opening a Project

To open an existing project:

- 1 Select File/Open Project from the menu bar, then select the desired .pmd file. The following caution is displayed.



**Figure 3-4:**  
Upload  
caution  
message

- 2 If necessary, turn off motors that are currently attached.
- 3 In the Project window, select the axis you want to work on.

### 3.6.3 Saving a Project File

To save the current project, select File/Save from the menu bar and assign the project a .pmd file name.

**NOTE:** *Pro-Motion will restore the current connections when restarted.*

## 3.7 Setting Module Properties

The Module Properties window (Figure 3-5) is used to set global properties, in contrast to axis-specific settings.

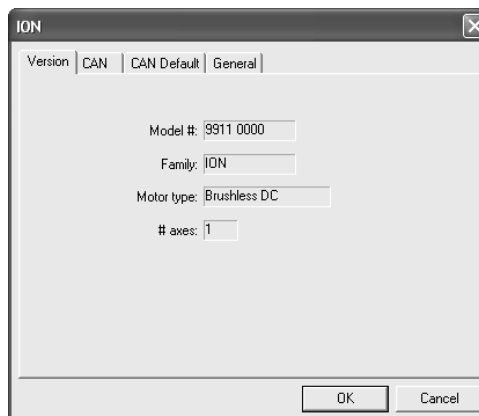

**Figure 3-5:**  
Setting  
module  
properties

The Module Properties window has three to six pages, depending on the controller type, and may include the following:

- The Version page displays the version information of the motion processor.
- The Serial page displays the motion processor's serial port settings. If Pro-Motion is connected via the serial port, changing these settings will change the processor's port settings as well as the host computer's port settings to maintain communications.
- The CAN page displays the motion processor's CAN port settings. If Pro-Motion is connected via the CAN port, changing these settings will change the processor's port settings as well as the host computer's port settings to maintain communications.
- The RS485 default page displays the ION's power-on default RS485 serial port settings. These settings are stored in the EEPROM and used when the RS485 mode is enabled via pin1 of the DB9 connector. To store the current settings in the EEPROM, click the "Store as power-on default" button.
- The CAN default page displays the ION's power-on default CAN port settings. These settings are stored in the EEPROM and used when the ION is powered on. To store the current settings in the EEPROM, click the "Store as power-on default" button.
- The User IO page displays the 8-bit user input and output signal state. The input state is shown by the radio buttons on the left and the output state is shown and altered by the check boxes on the right.
- The General page displays the cycle time of the motion processor.

*This page intentionally left blank.*

## *In This Chapter*

- ▶ Overview of the Control Window
- ▶ Motor Type
- ▶ Trajectory Module
- ▶ Position Loop Module
- ▶ Motor Control Module
- ▶ Current Loop Module
- ▶ Phasing Module
- ▶ Motor Output Module
- ▶ Feedback Module
- ▶ Operating Mode Module
- ▶ Tracking Module
- ▶ Limit Switches Module
- ▶ Breakpoints Module
- ▶ Axis I/O Module
- ▶ Event Manager
- ▶ Units

## 4.1 Overview of the Control Window

The Control window is used to access the controls for most of the motion processor functions, allowing you to set trajectories, position loop parameters, feedback preferences, and much more. This chapter provides descriptions of the options available in the Control window and information on how to use each option.

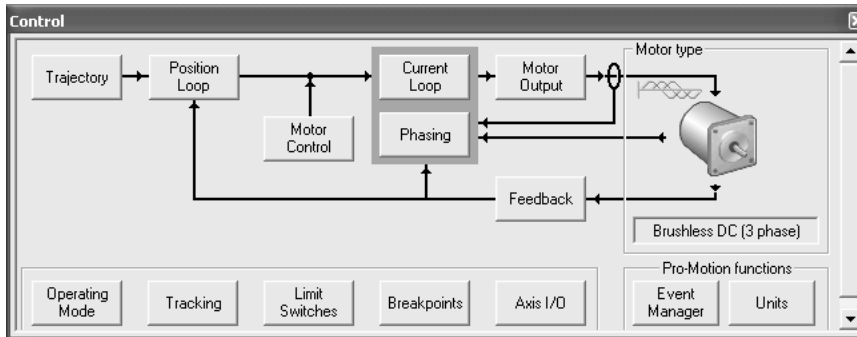

**Figure 4-1:**  
**Control window**

### 4.1.1 The Control Window Display

The Control window (Figure 4-1) displays the modules used to set up, run, and monitor motion, each module of the diagram represents a functional area used to control an axis. A set of the modules is arranged to illustrate the over-all control flow for an axis, with arrows identifying feedback and control paths.

**NOTE:** *The specific modules displayed will vary, depending on the motor type selected. For example, because servo parameters cannot be set for stepping motors, when the motor type is set to microstepping or pulse & direction, the Position Loop option is not displayed in the Control window.*

### 4.1.2 Accessing the Control Window

To open or close the Control window, select the Control icon from the toolbar (or select View/Control from the menu bar) or select the Normal icon (or View/Normal View from the menu bar).

### 4.1.3 Control Modules

The following table describes the modules available in the Control window and identifies the section of this chapter in which each module is described.

Module	Use	See Section
Motor Type (Magellan only)	Setting the motor type for the selected axis.	4.2
Trajectory	Setting a trajectory or running the Motion Shuttle.	4.3
Position Loop	Setting the parameters used to correct the motor position (servo loop).	4.4
Motor Control	Setting output-specific motor parameters.	4.5
Current Loop	Changing the mode of current control; setting the parameters used to correct for current fluctuations.	4.6
Phasing	Setting the parameters for initializing the phasing of the brushless DC motor and testing the settings.	4.7
Motor Output	Setting the form of the motor output signal(s)	4.8
Feedback	Identifying the type of encoder (position feedback device) that is connected to the motor.	4.9
Operating Mode	Setting the operating mode of the axis.	4.10
Tracking	Defining motion and position parameters against which to identify motion and position error.	4.11
Limit Switches	Defining the action the system will take when the positive or negative travel limits switches are tripped.	4.12

Module	Use	See Section
Breakpoints	Defining breakpoint conditions and the actions to be taken when the breakpoint occurs.	4.13
Axis I/O	Setting the axis in and axis out pin settings.	4.14
Event Manager	Setting preferred responses for a set of critical events.	4.15
Units	Setting preferred units of measure for space and time.	4.16

For more detailed descriptions of processor parameters, refer to the *Magellan Motion Processor User's Guide* and the applicable commands in the *Magellan Motion Processor Programmer's Command Reference* for your Magellan or ION product.

**NOTE:** *When setting up an axis for the first time, use the Axis Wizard. For more information about the Axis Wizard, refer to Chapter 6.*

## 4.2 Motor Type

The Magellan family of Motion Processors is designed to work with DC brush, brushless DC, microstepping, and pulse & direction motor types. In addition to accessing the control modules, the Control window allows you to select the appropriate motor type. Available motor type options are listed in the following table.

Motor Type	Description
Brushless 3-Phase	Servo motor requiring external 3-phase electrical commutation.
Brushless 2-Phase	Servo motor requiring external 2-phase electrical commutation.
Microstepping 3-Phase	3-phase step motor with microstepping drive.
Microstepping 2-Phase	2-phase step motor with microstepping drive.
Pulse & Direction	Step motor with pulse and direction drive.
DC brush	Servo motor with internal mechanical commutation.

To select a motor type, use the dropdown list in the Motor type area of the Control window. Note that when a motor type is selected, diagrams of the motor type's signalling are also displayed and the set of Control modules is changed to reflect the selected motor type.

## 4.3 Trajectory Module

The Trajectory module (Figure 4-2) is used to get the motor to move using the motion processor's trajectory monitor. The module is utilized by selecting a motion profile mode (trapezoidal, velocity contouring, S-curve, or electronic gear), setting the trajectory parameters for that profile, selecting a motion shuttle mode (single move, manual, or automatic), defining the motion parameters (if any), and then pressing the Go button to move the motor.

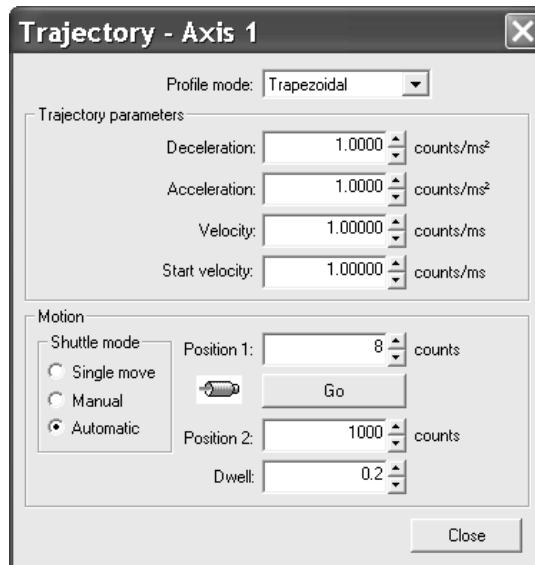

**Figure 4-2:**  
Trajectory  
dialog box

### 4.3.1 Using the Trajectory Dialog Box

To set a trajectory and use the motion shuttle:

- 1 Select the desired Profile mode. The applicable settings for the selected Profile mode will be displayed below in the Trajectory parameters box.
- 2 Set the desired trajectory (motion) parameters. (For available options for each profile mode, refer to the tables in Section 4.3.2.)
- 3 Using the information below and in Section 4.3.3, select one of the motion shuttle modes and enter the desired values.



<b>Shuttle</b>		
<b>Mode</b>	<b>To start a motion</b>	<b>Result</b>
Single move	Enter a value for Position 1, then click Go.	The motor will run to Position 1 and stop.
Manual	Enter values for Position 1 and Position 2, then click Go.	The motor will run to Position 1 and stop. Click Go again to move the motor to Position 2.
Automatic	Enter values for Position 1 and Position 2, and set the time the axis should pause between moves (Dwell time), then click Go.	The motor will run to Position 1, pause for the Dwell time, then return to Position 2. Click Stop to end the motion.

- Click Go to start the trajectory. You can monitor the motor's activity in the Status window, which is located below the Control window in Normal View or is available by clicking the Status icon on the tool bar (or selecting View/Status on the menu bar).

### 4.3.2 Trajectory Profile Options

The Trajectory profile modes include trapezoidal, velocity contouring, S-curve, and electronic gear, for each of which a unique set of trajectory and motion parameters can be set. The available trajectory profile modes and their applicable parameters are described in this section.

#### Trapezoidal Profile Options

The Trajectory options available for the trapezoidal profile mode are listed in the following table. For a detailed description of the trapezoidal profile mode, see "Trapezoidal point-to-point profile" in Chapter 4 of the *Magellan Motion Processor User's Guide*.

<b>Section</b>	<b>Options</b>
Trajectory parameters	Deceleration Acceleration Velocity Start velocity (Applicable to stepping motor types only)
Motion box options	
Shuttle mode	Single move Manual Automatic

Section	Options
Position	Position 1 (applicable to all shuttle modes) Position 2 (applicable to Manual and Automatic modes) Dwell (applicable to Automatic mode only) Go/Stop button (applicable to all shuttle modes)

### Velocity Contouring Profile Options

The Trajectory options available for the velocity contouring profile mode are listed in the following table. For a detailed description of the velocity contouring profile mode, see “Velocity-contouring profile” in Chapter 4 of the *Magellan Motion Processor User’s Guide*.

Section	Options
Trajectory parameters	Deceleration Acceleration Velocity
Motion box	Go/Stop button

### S-curve Profile Options

The trajectory options for the S-curve profile mode are shown in the following table. For a detailed description of the S-curve profile mode, see “S-curve point-to-point profile” in Chapter 4 of the *Magellan Motion Processor User’s Guide*.

Section	Options
Trajectory parameters	Jerk Acceleration Velocity
Motion box	
Shuttle mode	Single move Manual Automatic
Position	Position 1 (available for all Shuttle modes) Position 2 (available for Manual and Automatic modes) Dwell (available for Automatic mode only) Go/Stop button (available for all Shuttle modes)

### Electronic Gear Profile Options

The trajectory options for the electronic gear profile mode are shown in the following table. For a detailed description of the electronic gear profile mode, see “Electronic gear profile” in Chapter 4 of the *Magellan Motion Processor User’s Guide*.

Section	Options
Master axis	Applicable axis, selected from dropdown list.
Source position data	Actual or Commanded.
Gear ratio	The direction and ratio of master gear counts to slave counts.

### 4.3.3 Motion Shuttle Modes

Available motion shuttle modes are described in the following table.

Shuttle Mode	Result
Single move	The motor runs to Position 1 and stops.
Manual	The motor runs to Position 1 and stops, then must be started again (by clicking Go) to move to Position 2.
Automatic	The motor runs to Position 1, pauses for the specified Dwell time, and returns to Position 2. The motion will continue until you click Stop.

## 4.4 Position Loop Module (Servo Motors Only)

The Position Loop module (Figure 4-3) is used to set the PID filter for servo motors. The PID filter generates a motor command from the position error, which is the commanded position minus the actual position from the encoder.

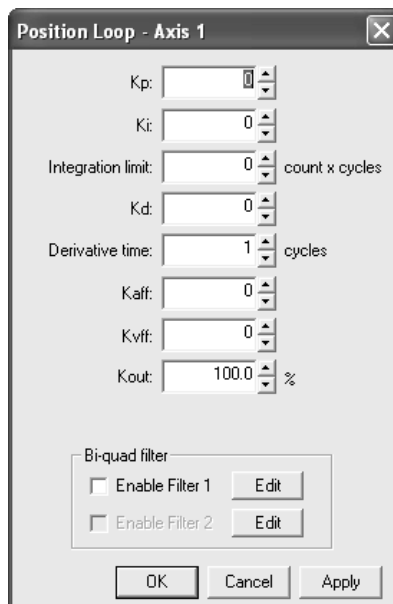

**Figure 4-3:**  
Position Loop  
dialog box

**CAUTION:** *The position loop settings are generally changed while the axis is at rest. Although it is possible to change the parameters while the axis is in motion, exercise caution when changing the parameters to avoid unexpected and/or dangerous motion.*

### 4.4.1 Using the Position Loop Dialog Box

To set and tune the Position Loop parameters:

**NOTE:** *For definitions of the Position Loop parameters, refer to Section 4.4.2.*

- 1 Using the Tuning view, set the initial proportional gain (Kp) and Derivative gain (Kd) parameters in the Position Loop dialog box to small values.
- 2 Verify the position loop response by jogging the motor.
- 3 Increase Kp and Kd until the actual position follows the commanded position as closely as possible with no overshoot.
- 4 When Kp and Kd provide stable and responsive motion, set the Integral gain (Ki) to reduce any position error when the motor is stationary. The integration limit must be non-zero for Ki to have an effect.
- 5 Enable or disable the biquad filtering function, and, if filtering is enabled, set the filter parameters. For detailed instructions, refer to Section 4.4.3.
- 6 Click Apply to accept the Position Loop settings, or click OK to accept the settings and close the dialog box. Click Cancel to abort.

### 4.4.2 Position Loop Module Options

The Position loop parameters are described in the tables below. For more detailed information about the Position loop, refer to Chapter 5 in the *Magellan Motion Processor User's Guide*.

Field	Factors
Kp	Sets the Proportional gain of the digital Position loop for the axis. Motor output = Kp x position error.
Ki	Sets the Integral gain of the filter for the axis, which closes the position gap over time.
Integration limit	Sets the boundary on the absolute value contributed to the PID output by the integration term.
Kd	Sets the Derivative gain, which dampens any rapid change in motion.
Derivative time	The interval, in cycles, at which the derivative is computed.
Kaff	Sets the Acceleration feed-forward gain for the axis.
Kvff	Sets the Velocity feed-forward gain for the axis.
Kout	Sets the factor used to scale down the output of the PID filter.
Dual loop source	Identifies the axis used to augment the primary (load) encoder.

Field	Factors
Biquad filters	Generic, programmable digital filters. Two programmable biquad output filters are supported for each axis. When both are enabled, the output of Filter 0 feeds the input of Filter 1. If Filter 0 is disabled (default), Filter 1 cannot be enable and the filter chain is bypassed.
Filter coefficients	Accessible from “Edit” buttons in biquad options box. For a discussion of filter coefficients, refer to “Biquad Output Filters” in Chapter 5 of the <i>Magellan Motion Processor User’s Guide</i> .

### 4.4.3 Setting Biquad Filter Parameters

A biquad filter is a generic digital filter structure that can be programmed with coefficients to be a low-pass filter, high-pass filter, band-pass filter, notch filter, or custom filter.

Once calculated, the biquad filter coefficients are entered in the Filter Coefficients dialog box (Figure 4-4), which is accessed from the Edit button associated with each biquad option in the Position Loop dialog box.

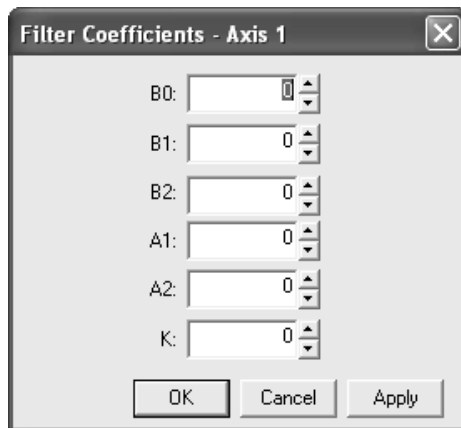

**Figure 4-4:**  
Filter  
Coefficients  
dialog box

**NOTE:** *The biquad filters in Magellan products are chained; Filter 1 can be enabled only if Filter 0 has been enabled.*

To set the biquad filtering function:

- 1 Calculate the appropriate filter coefficients. For instructions and formulae for determining the appropriate biquad coefficients, refer to “Biquad Output Filters” in Chapter 5 in the *Magellan Motion Processor User’s Guide*. To find the coefficients, see also the Octave program ([www.octave.org](http://www.octave.org)).
- 2 Select Edit to open the Filter Coefficients dialog box.

- 3 Set the filter coefficient parameters specific to the selected biquad filter.
- 4 Select OK to enable the biquad filtering and close the dialog box.
- 5 When the parameters for both filters have been set as desired, click Apply to set these as the active servo parameters in the chipset.

#### 4.4.4 Tuning a Servo Motor

When using servo motors, to maximize system performance it is important to optimize tuning parameters. The tuning parameters derived in the Axis Wizard may or may not be optimum; therefore you may want to tune the position loop manually to improve system performance.

To tune a servo motor:

- 1 Select the Tuning View icon (or View/Tuning View) to open the oscilloscope along with the Position Loop and Step Function dialog boxes.

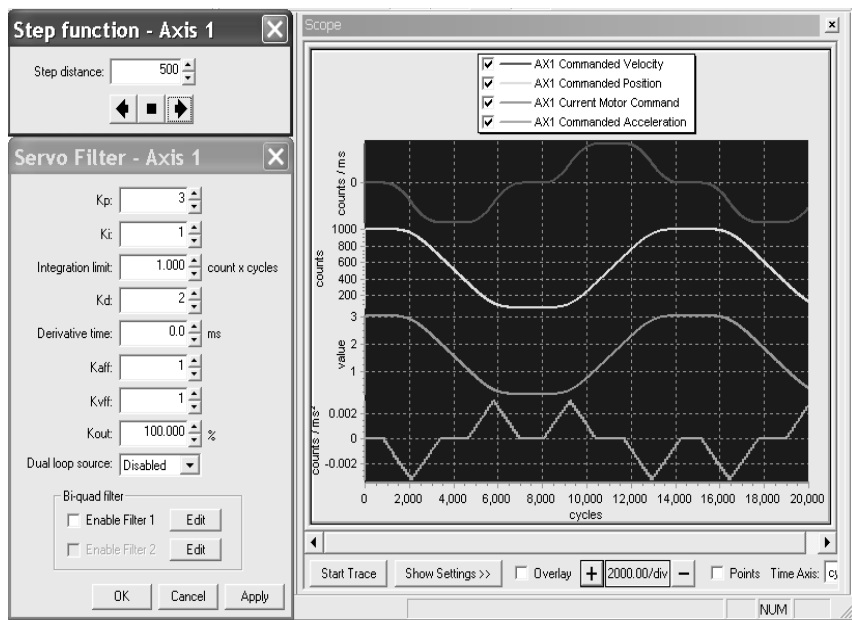

**Figure 4-5:**  
Tuning view

- 2 In the Step Function dialog box, set the distance the motor will move. Keep in mind that the step function causes an instantaneous move at maximum acceleration and velocity. An overcurrent condition may occur if the step distance is set too high.

- 3 Adjust the settings in the Position Loop dialog box as indicated by the trace (see Section 4.4.1).
- 4 Click a directional arrow in the Step Function dialog box to jog the motor, and monitor the motion on the oscilloscope to verify the servo loop response.
- 5 Repeat Steps 2 and 3 until the oscilloscope demonstrates that the motion is stable and the actual position follows the commanded position as closely as possible with no overshoot.

## 4.5 Motor Control Module

The Motor Control module is used to set output-specific motor parameters (for example, a motor command limit and a motor bias). The module is also used to control the motor command manually during motor or amplifier calibration.

The fields available in the Motor Control dialog box (Figure 4-6) depend on motor type and product type. For brushless DC and DC brush motor types, the Motor command, Motor bias, and Motor limit can be set. For microstepping motors, only Motor command can be set. The Motor Control module is not available for pulse & direction motors.

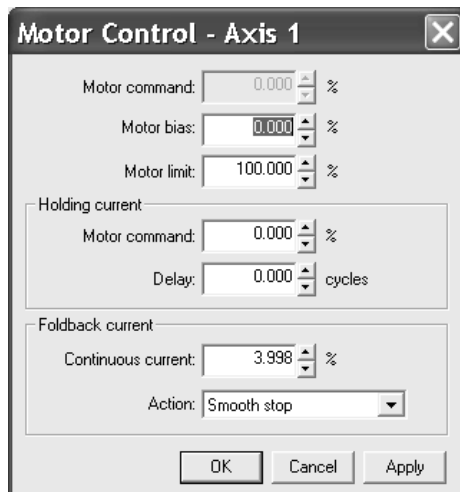

**Figure 4-6:**  
Motor Control  
dialog box  
(brushless DC  
and DC brush  
motors)

### 4.5.1 Using the Motor Control Dialog Box

The Motor Control dialog box can be used to operate a servo motor in open loop.

- 1 Disable the position loop and trajectory operating modes in the Operating Mode dialog.
- 2 Use the Motor command field to set the speed/torque of the motor.
- 3 Click Apply to start the motor.

### 4.5.2 Motor Control Module Options

Available Motor Control settings are described in the following table.

Field	Available for:	Description	
Motor command	Brushless DC DC brush	Directly sets the Motor Output register when the Position Loop and Trajectory Generator modules are disabled in the Operating Mode.	
	Microstepping	Sets the magnitude of the output waveform.	
Motor bias	Brushless DC DC brush	Amount added to the Motor Output register when the position loop is enabled. Primarily used to prevent a vertical axis from falling in the event of a motion error.	
Motor limit	Brushless DC DC brush	Prevents the filter output from exceeding a boundary magnitude in either direction.	
Holding current	Motor command	Microstepping	Amount of constant current to hold the motor when stationary.
	Delay	Microstepping	Amount of time to wait after the end of move before going into holding current.
Foldback current	Continuous current	ION	Amount of continuous current while in foldback.
	Action	ION	Action to take when current foldback occurs.



### 4.5.3 Current Foldback Responses

The available current foldback responses are described in the following table.

Action	Response
None	No action taken.
Abrupt stop	Instantaneous halt of the trajectory generator; velocity command then set to zero.
Smooth stop	Smooth stop at the current active deceleration rate; velocity then set to zero.
Disable position loop	Trajectory generator and position loop modules are disabled.
Disable current loop	Trajectory generator, position loop, and current loop modules are disabled.
Disable motor output	Trajectory generator, position loop, current loop, and motor output modules are disabled.
Abrupt stop with clear position error	Instantaneous halt of the trajectory generator; velocity command then set to zero. Also clears the position error.

Refer to the *Magellan Motion Processor User's Guide* for more information on the following topics:

- For Motor command see Chapter 11.
- For Motor bias and Motor limit, see Chapter 5.
- For current foldback, see Chapter 15.
- For holding current, see Chapter 14.

Refer also to the applicable commands in the *Magellan Motion Processor Programmer's Command Reference*.

## 4.6 Current Loop Module

The Current Loop module allows the user to change the mode of current control to field oriented control (FOC) or current loop and set the gain factors for the proportional, integral (PI) controller and the limit for the integral contribution (Integration limit).

**Figure 4-7:**  
Current Loop  
dialog box

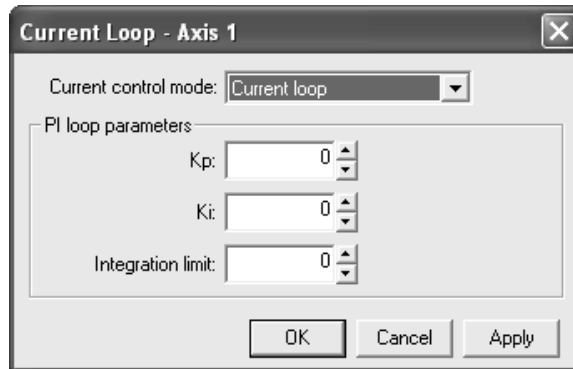

**NOTE:** To automatically determine the optimum current loop parameters, use the current loop tuning feature of the Axis Wizard.

### 4.6.1 Setting Current Loop Parameters

To set the Current Loop parameters:

- 1 Select the desired Current control mode: Current loop or Field oriented control.
- 2 Set the desired proportional gain ( $K_p$ ) and integrational gain ( $K_i$ ) parameters and the Integration limit.
- 3 Click Apply to activate the settings without closing the dialog box, or click OK to activate the settings and close the dialog box. Click Cancel to abort.

For more information, refer to Chapter 15 of the *Magellan Motion Processor User's Guide* and the related commands from the *Magellan Motion Processor Programmer's Command Reference*.

## 4.7 Phasing Module

The Phasing module (Figure 4-8) is used to set the parameters that establish and maintain the motor commutation for brushless DC motors. The Axis Wizard can help determine these automatically.

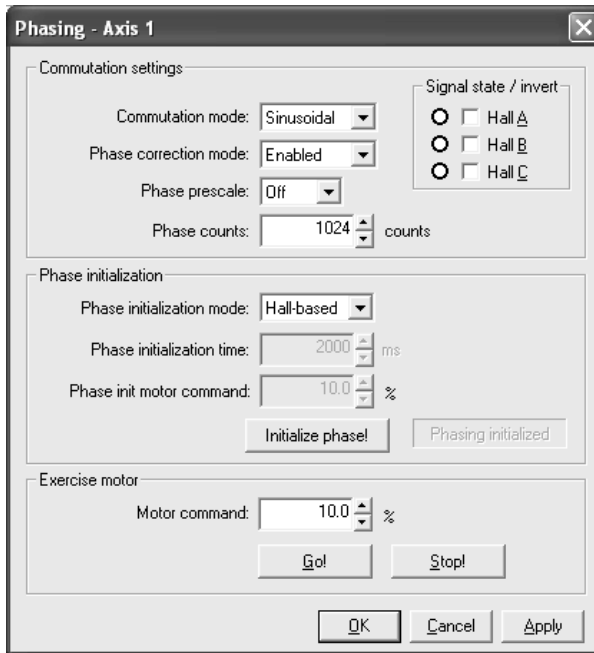

**Figure 4-8:**  
Phasing  
dialog box

The functions of the Phasing dialog box are defined by its three units:

Unit	Use
<b>Commutation settings</b>	Allows the user to establish the basic setup parameters, such as commutation method, counts per electrical cycle, and so forth.
<b>Phase initialization</b>	Allows the user to initiate the processor's commutation algorithm.
<b>Exercise motor</b>	Allows the user to test motor rotation in order to verify proper commutation.

**NOTE:** *Phasing parameters are set when the Axis Wizard is run and typically are not changed after that (except to re-initialize commutation if proper commutation was lost due to a power cycle, reset, or commutation error).*

### 4.7.1 Using the Phasing Dialog Box

The Phasing dialog box is used to set Phasing options for either the Sinusoidal mode or the Hall-based mode and then verify the commutation in three stages:

- 1 Setting the Commutation parameters.
- 2 Initializing the phase.
- 3 Exercising the motor to test the commutation.

**NOTE:** For definitions of the Phasing parameters, refer to Section 4.7.3.

#### Setting Phasing Options for the Sinusoidal Commutation Mode

To set Phasing options for the Sinusoidal mode:

- 1 Select the Sinusoidal Commutation mode.
- 2 Set the Phase initialization mode, Phase correction mode, Phase prescale, and Phase counts parameters.
- 3 Use the following table to determine your next step:

<b>If the Phase initialization mode is...</b>	<b>Then...</b>
Algorithmic	Set the Phase initialization time and Phase init motor command, which should be sufficient to hold the motor shaft.
Hall-based	Verify the Signal sense.

- 4 Click Initialize phase!, which applies the changes and initializes phasing. If phase initialization mode is set to algorithmic, the motor will rotate approximately 1 electrical cycle.
- 5 Verify the commutation by running the motor in open loop mode, following the instructions in “Verifying the Commutation” in Section 4.7.2.

#### Setting Phasing Options for Hall-based Commutation Mode

To set Phasing options for Hall-based mode:

- 1 Select the Hall-based Commutation mode. The Signal states field is displayed (Figure 4-9) and the remaining parameters are grayed out.
- 2 If necessary, select the appropriate Invert check box(es) to invert an inactive Signal state(s). (Radio buttons reflect the current state of the signal.)

- 3 Click Initialize phase or Apply.
- 4 Verify the commutation by running the motor in open loop mode, following the instructions in Section 4.7.2.

## 4.7.2 Verifying the Commutation

To verify the commutation, run the motor in open loop mode:

- 1 Set the Motor command parameter (located in the Motor Control dialog box) to a low value (between 1% and 15%), keeping in mind that the motor may start to move at a rate proportional to the motor command setting.
- 2 Click the Go! button in the Exercise Motor box.

If...	Then...
The motion occurs smoothly in a single direction	The motor is commutating properly. Click the Stop! button to stop the motion.
The motion is not smooth or is stuck	The motor is not commutating correctly. Re-run the Axis Wizard, check the encoder and Hall connections in the appropriate Control window, or consult PMD.

## 4.7.3 Phasing Module Options

The Phasing module options are described in the following table.

For more information, refer to Chapter 12 of the *Magellan Motion Processor User's Guide* and the related commands from the *Magellan Motion Processor Programmer's Command Reference*.

Field (unit)	Description
Commutation mode	<p>Sinusoidal = As the motor turns, encoder input signals are used to calculate the phase angles and generate sinusoidally varying outputs to each motor winding.</p> <p>Hall-based = Hall-effect sensor inputs are used to commutate the motor windings using a six-step or trapezoidal waveform method. If selected, only the Motor command fields remain active.</p>
Phase initialization mode	<p>Algorithmic mode briefly stimulates the motor windings and sets the initial phasing based on the observed motor response.</p> <p>Hall-based mode determines the motor phasing from the state of the 3 hall sensor signals.</p>

Field (unit)	Description
Signal state/invert: - Hall A - Hall B - Hall C	The radio buttons reflect the current signal state of the hall signal. The check boxes are used to invert the signal sense of the hall signals.
Phase correction mode	When phase correction is enabled, the encoder index signal is used to update the commutation phase angle once per motor revolution. This ensures that the commutation angle will remain correct even if some encoder counts are lost due to electrical noise, or due to the number of encoder counts per electrical phase not being an integer.
Phase prescale	The amount to scale the encoder counts before they are used to calculate a commutation angle. Enable prescaling if the number of counts per electrical cycle exceeds 32767.
Phase counts	Sets the number of encoder counts per electrical cycle.
<b>Initialize commutation box</b>	
Phase initialization time	Sets the duration of each of the four segments in the phase initialization algorithm. The field is not active if Phase initialization mode is Hall-based.
Phase init motor command	Determines the overall amount of power to introduce into the motor during phase initialization.
Initialize phase! button	When phase initialization mode is algorithmic this will begin the phase initialization process by moving the motor.  When phase initialization mode is hall-based this will initialize the phasing by reading the hall signals. No motor rotation will occur.
<b>Exercise motor box</b>	
Motor command	The percentage of voltage to apply to the motor in open-loop mode.
Go! and Stop! buttons	Start and stop open-loop motor operation respectively. Note: the position loop, current loop and trajectory operating modes will be disabled. Only the Motor output operating mode is affected.

## 4.8 Motor Output Module

The Motor Output module is used to set output signal and amplifier parameters.

### 4.8.1 ION Only

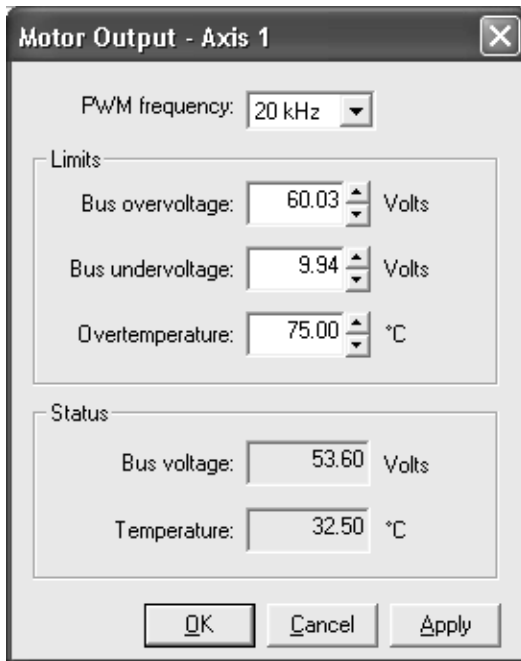

**Figure 4-9:**  
Motor Output  
dialog box  
(ION only)

### 4.8.2 Magellan Only

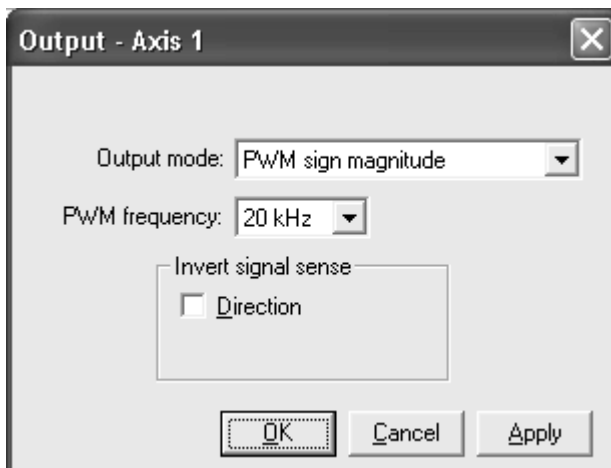

**Figure 4-10:**  
Motor Output  
dialog box  
(Magellan  
only)

### 4.8.3 Using the Motor Output Dialog Box

Field	Description
PWM frequency	Sets the frequency of the pulse width modulated output signal.
Output mode (Magellan only)	Sets the motor output signal format.
Bus overvoltage (ION only)	Sets the input voltage limit that will cause an overvoltage condition if exceeded
Bus undervoltage (ION only)	Sets the input voltage limit that will cause an undervoltage condition if the input voltage falls below this amount
Overtemperature (ION only)	Sets the temperature that will cause an overtemperature condition if exceeded.

## 4.9 Feedback Module

The Feedback module (Figure 4-11) is used to select the type of position feedback device (encoder) that is connected to the motor.

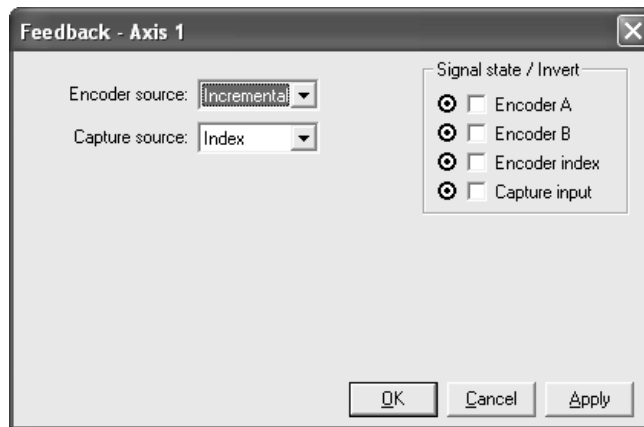

**Figure 4-11:**  
Feedback dialog box

### 4.9.1 Using the Feedback Dialog Box

To change parameters in the Feedback dialog box:

- 1 In the Encoder source field, select the appropriate source: Incremental or None.
- 2 In the Capture source field, select the desired position: Index or Home.
- 3 In the Signal state/invert box, click in the appropriate check box to invert a signal.
- 4 Click Apply to activate the settings without closing the Feedback dialog box, or click OK to activate the settings and close the dialog box. Click Cancel to abort.



## 4.9.2 Feedback Module Options

The available Feedback module options are described in the following table.

Encoder type	Description
Encoder source	Selects the type of encoder connected to the axis: incremental (quadrature encoder A-B signals), parallel, or none
Capture source	Selects the input signal that will be used for the position capture feature.
Encoder to step ratio (stepping motors only)	Sets the ratio of the number of encoder counts to motor output steps. This is primarily used for stall detection with stepping motors.
Signal state/invert	Displays the current input signal states and sets the input signal sense.

For more information, refer to Chapter 10 in the *Magellan Motion Processor User's Guide*, the related commands from the *Magellan Motion Processor Programmer's Command Reference*, and Section 6.2 in this user's guide.

## 4.10 Operating Mode Module

The Operating Mode module (Figure 4-12) shows which of the motion processor's control modules are currently active. The module can be used to selectively enable or disable specific control modules.

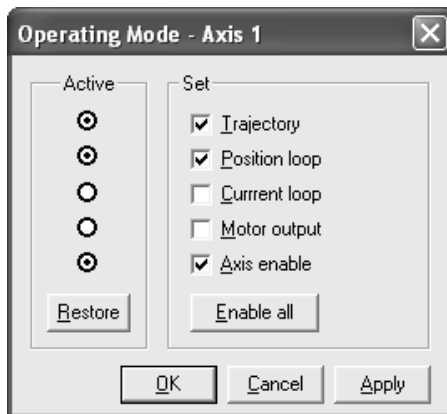

**Figure 4-12:**  
Operating  
Mode dialog  
box

When a module is enabled, its Active circle is filled; conversely, when the circle is empty, the module is disabled.

The current loop option is available only with the ION. The position loop option is available only with servo motors.

### 4.10.1 Using the Operating Mode Dialog Box

To change a control module's status:

- 1 Select the Set box of the module(s) whose status is to be changed.
- 2 Click the Apply button. The Active indicators will indicate that the status of the selected modules has been changed.
- 3 Click OK to exit or click Cancel to cancel your action.

For more information, refer to “Enabling and Disabling Control Modules” in Chapter 3 of the *Magellan Motion Processor User's Guide*.

## 4.11 Tracking Module

The Tracking module (Figure 4-13) is used to set the axis position monitoring parameters for which motion is to be tracked:

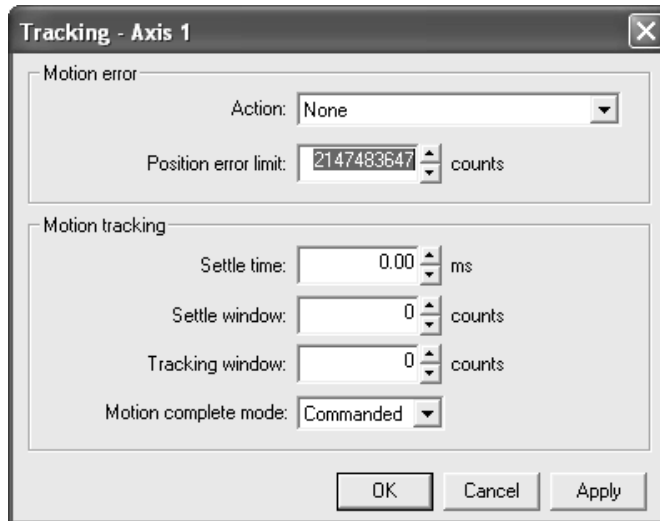

**Figure 4-13:**  
Tracking  
dialog box

The Motion error options define:

- The action to be taken when the Position error limit is exceeded.
- The maximum allowed magnitude of the position error before a motion error condition occurs.

The Motion tracking options define:

- The maximum allowed magnitude of the position error for the tracking mechanism and for the “at settle” mechanism.
- The amount of time allowed for the axis to settle.
- Whether or not the motion complete status bit will utilize the commanded position or the actual encoder position to determine if motion is complete.

### 4.11.1 Using the Tracking Dialog Box

To set the Tracking options:

- 1 In the **Action** field, select the action the motor should take when the position error limit is reached:
  - None
  - Abrupt stop
  - Smooth stop
  - Disable position loop
  - Disable current loop
  - Disable Motor Output
  - Abrupt stop with clear position error

**NOTE:** For descriptions of these options, refer to Section 4.5.3.

- 2 In the Position error limit field, set the value of the maximum position error to be allowed by the motion processor.
- 3 Complete the Settle time, Settle window, Tracking window, and Motion complete mode fields as described Section 4.11.2.
- 4 Click Apply to activate the settings without closing the dialog box or click OK to activate the settings and close the dialog box. Click Cancel to abort.

For more information, refer to Chapter 7 in the *Magellan Motion Processor User's Guide* and the related commands from the *Magellan Motion Processor Programmer's Reference*.

### 4.11.2 Tracking Options

The options available in the Tracking module are described in the following table

Field	Description
Settle time	Sets the time the axis must remain in the position range specified in Settle window before the axis-settled bit in the Activity Status register is set.
Settle window	Sets the position range within which the axis must remain for the duration specified in Settle Time before the axis-settled bit in the Activity Status register is set.
Tracking window	Sets boundaries for position error of the axis. If the position error exceeds this value at any time, the tracking indicator is set to 0 (off). When position error returns to within the limit, the tracking indicator is set to 1 (on).
Motion complete mode	Commanded = Motion is complete when the profile velocity reaches zero (0). Actual = Motion is complete when the actual position has been within the specified Settle window for the specified Settle time.

## 4.12 Limit Switches Module

The Limit Switches module (Figure 4-14) is used to define the action that the motion processor will take when those limits are tripped.



**Figure 4-14:**  
Limit  
Switches  
dialog box

### 4.12.1 Using the Limit Switches Dialog Box

To enable the Limit switches:

- 1 Verify whether or not the Positive and Negative switches are active. (When a switch is active, its Active circle is filled; conversely, when the circle is empty, the switch is inactive.)
- 2 To invert the state of a signal from positive to negative or vice versa, select the appropriate Invert check box.
- 3 Select the preferred response for when a positive or negative limit is reached:
  - Abrupt stop
  - Smooth stop
  - Disable position loop
  - Disable current loop
  - Disable Motor Output
  - Abrupt stop with clear position error

**NOTE:** For descriptions of these options, refer to Section 4.5.3.

- 4 Click Apply to activate the settings without closing the dialog box, or click OK to activate the settings and close the dialog box. Click Cancel to abort.

For more information about limit switches, refer to “Travel-limit switches” in Chapter 8 of the *Magellan Motion Processor User’s Guide* and applicable commands in the *Magellan Motion Processor Programmer’s Command Reference*.

## 4.13 Breakpoints Module

The Breakpoints module allows the user to define up to two different breakpoint conditions and the action that is to be taken when a defined breakpoint is reached (Figure 4-15).

**Figure 4-15:**  
**Breakpoints**  
**dialog box**

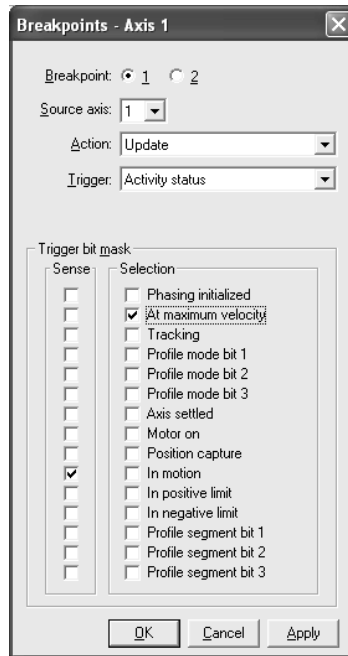

### 4.13.1 Using the Breakpoints Dialog Box

To set up the breakpoint parameters:

- 1 In the Breakpoint field, select 1 (or 2, if Breakpoint 1 is already set up).
- 2 In the Source axis field, select the number of the axis on which the triggering event will be located.
- 3 In the Action field, select the action that should occur when the breakpoint is reached:
  - None
  - Update
  - Abrupt stop
  - Smooth stop
  - Disable position loop
  - Disable current loop
  - Disable Motor Output
  - Abrupt stop with clear position error

**NOTE:** For descriptions of these options, refer to Section 4.5.3.

- 4 In the Trigger field, select the event that will trigger the breakpoint action:
  - None
  - =>Commanded position
  - =>Actual position
  - =<Commanded position
  - =<Actual position
  - Commanded position crossed
  - Actual position crossed
  - Time
  - Event Status
  - Activity Status
  - Signal Status
  - Drive Status
- 5 In the Value field (if applicable), indicate the number of counts.
- 6 If appropriate for the selected trigger, the Trigger bit mask field will be displayed. Select the Sense and Selection option(s) for one or more bits of the selected status register.
- 7 Click Apply to activate the settings without closing the dialog box, or click OK to activate the settings and close the dialog box. Click Cancel to abort.

For more information about breakpoints, refer to Chapter 6 in the *Magellan Motion Processor User's Guide*.

## 4.14 Axis I/O Module

The Axis I/O module (Figure 4-16) is used to identify which bit(s) of the selected register is to be reflected on the *AxisOut* pin.

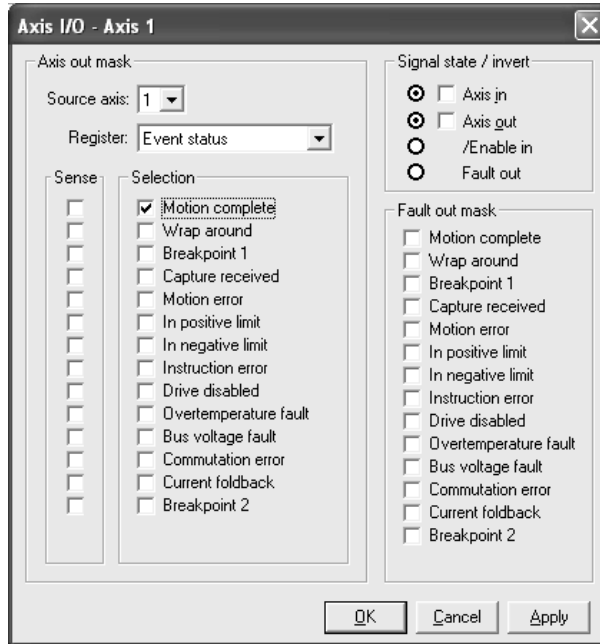

**Figure 4-16:**  
**Axis I/O**  
**dialog box**

To set the Axis I/O preferences:

- 1 In the Source axis field, select the number of the axis (1, 2, 3, or 4) from which to obtain the status register.
- 2 In the Register field, select the preferred source register:
  - Disabled (no register selected)
  - Event status
  - Activity status
  - Signal status
  - Drive status

A list of available bits for the selected register is displayed.

- 3 Select both the Sense and Selection check boxes for each bit you want to be reflected on the *AxisOut* pin.
- 4 Click Apply to activate the settings without closing the dialog box, or click OK to activate the settings and close the dialog box. Click Cancel to abort.



## 4.15 Event Manager Module

The Event Manager module (Figure 4-17) enables you to specify a desired response for Pro-Motion to take (Ignore or Display message) for each event listed.

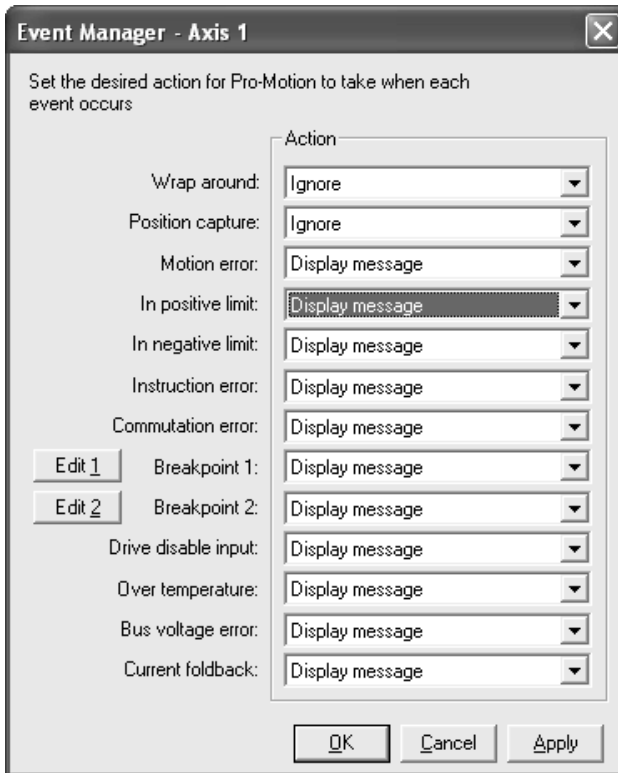

**Figure 4-17:**  
Event  
Manager  
dialog box

**NOTE:** *The last four events apply to the ION Digital Drive only.*

### 4.15.1 Using the Event Manager Dialog Box

To set the preferred response for each listed event:

- 1 Click Event Manager on the Control window to open the Event Manager dialog box.
- 2 For each event listed, select your preferred response, based on the information in the following table:

Response Type	Description
Ignore	No action will be taken.
Display message	Displays a pop-up message box notifying you of the particular event.

- Click Apply to activate the settings without closing the dialog box, or click OK to activate the settings and close the dialog box. Click Cancel to abort.

## 4.16 Units Module

The Units module (Figure 4-18) allows you to specify Time and Scale in real-world units, and then automatically translates your settings into counts when communicating with the motion processor.

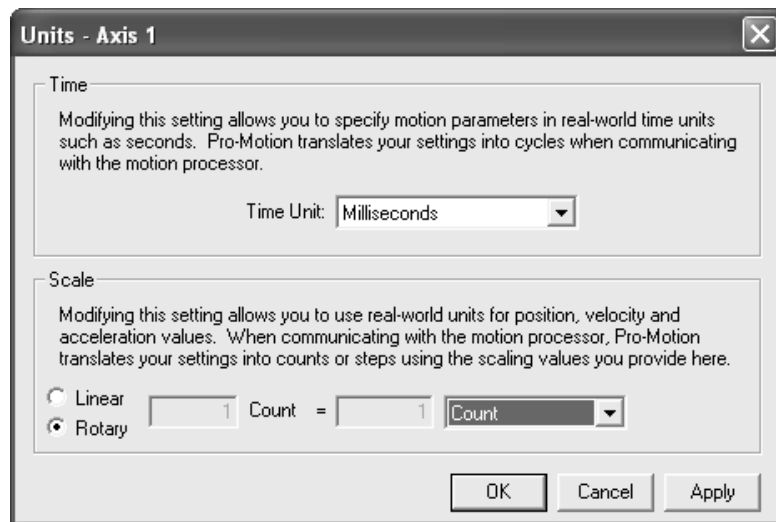

**Figure 4-18:**  
Units dialog  
box

- Time—Available time units for motion processor parameters that are based on time, such as trajectory. Options = Cycles, Milliseconds, Seconds, and Minutes.
- Scale—Scale units for position, velocity, and acceleration values, available for both linear and rotary type motors.
  - Linear units include Counts, Millimeters, Inches, Feet, and Meters.
  - Rotary units include Counts, Degrees, Radians, and Revolutions.

### 4.16.1 Using the Units Dialog Box

To set unit preferences:

- 1 Click Units in the Control window to open the Units dialog box.
- 2 Select the time and scale values appropriate for the selected axis.
- 3 Click Apply to activate the settings without closing the Units dialog box, or click OK to activate the settings and close the dialog box. Click Cancel to abort.

*This page intentionally left blank.*

## *In This Chapter*

- ▶ Introduction
- ▶ The Scope (Oscilloscope) Window
- ▶ The Status Window
- ▶ The Drive Status Window

## 5.1 Introduction

Pro-Motion provides four monitoring capabilities:

- Observing the trace of one to four selected motion processor parameters using the interactive oscilloscope in the Scope window.
- Observing the motor's position and status (Limit switches, in motion, etc.) in the Status window.
- Monitoring the communication activity between Pro-Motion and the motion processor in the Monitor window.
- Checking the amplifier bus voltage, temperature, and status of the currently active drive (ION only).

One or more of these features can be open on the desktop at all times, if desired.

## 5.2 The Scope (Oscilloscope) Window

The Magellan and ION motion processors allow the continuous capture of system parameters. The Pro-Motion oscilloscope, which is located in the Scope window (Figure 5-1), displays this data as it is captured from the motion processor's hardware trace buffer, in a flexible graphical format. The oscilloscope, which is interactive, has the capability to simultaneously display selected data for up to four variables at one time.

Features of the Scope window include:

- Virtual buffering of trace data, allowing for the display of traces many times longer than the capacity of the hardware trace buffer.
- Interactive zooming and scrolling of the trace data display.
- Interactive probing of individual data samples.
- Both separate and overlaid trace display modes.
- Saving capability for trace data (both image and settings).
- Printing and exporting of trace data.

For more information on the capabilities of the motion processor's trace facility, refer to "Trace Capture" in Chapter 8 of the *Magellan Motion Processor User's Guide*.

**Figure 5-1:**  
Scope  
window

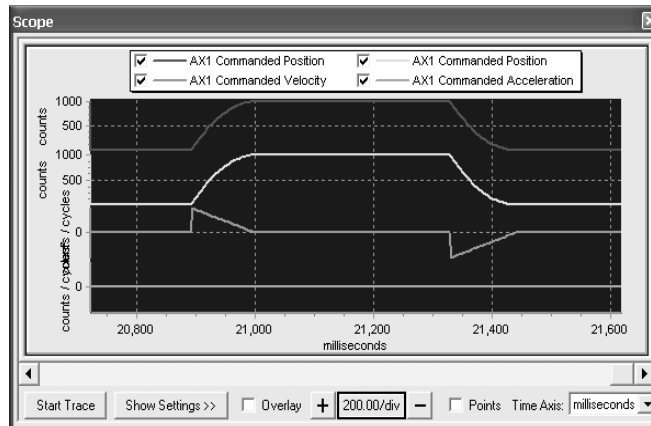

## 5.2.1 Using the Scope Window

To select or change the oscilloscope settings:

- 1 Select the Scope icon from the toolbar (or View/Scope from the menu bar) to open the Scope window.
- 2 Select Show Settings to display the available options. For detailed information on the oscilloscope options, see Section 5.2.2.
- 3 Select the Variable and Axis you want to track for each color.

**NOTE:** *If you select None (under Miscellaneous in the pull-down menu) for an axis, it and the axes that follow will not be tracked.*

- 4 To select the Trigger Conditions:
  - Select the Start trigger from the dropdown list of available options.
  - Select the desired axis.
  - If the Start trigger is Event, Activity, or Signal status, select the Start condition from the Bit dropdown list and set the Trigger State to 0 (off) or 1 (on).
- 5 In the Trace Period field, select the number of cycles to be covered by a single trace.

- 6 Select a Trace mode option:

Option	Description
One time	Monitoring ends when the motion processor's buffer is filled.
Rolling buffer	Monitoring is continuous.

- 7 To activate the selected changes and run the trace, click the **Start/Stop** button either in the Settings dialog box or below the oscilloscope.

**NOTE:** To close the Settings dialog box, click *Hide Settings*.

## 5.2.2 The Settings Dialog Box

The Settings dialog box (Figure 5-2) in the Scope widow allows you to select and configure up to four traces on the oscilloscope. Changes made to the settings are activated when the next trace is started.

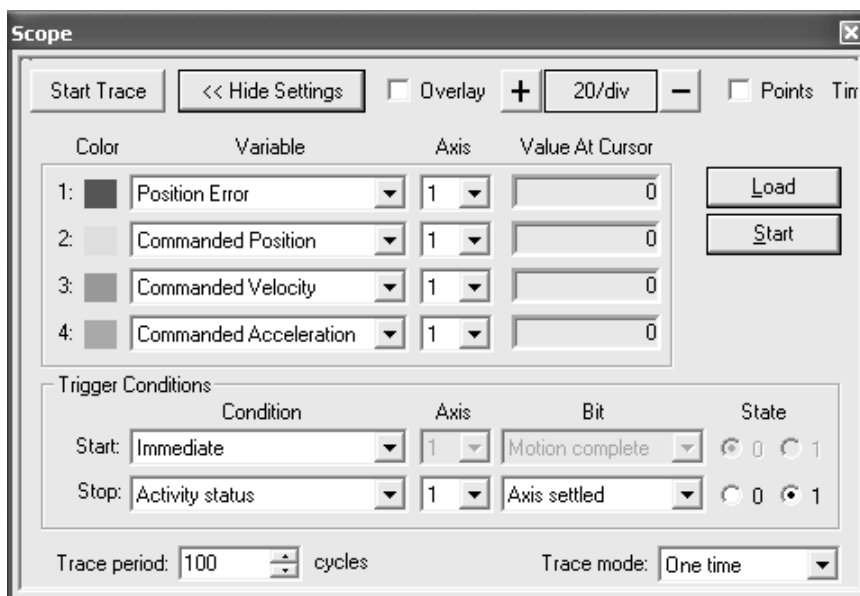

**Figure 5-2:**  
Scope  
Settings  
dialog box

The oscilloscope settings are described in the following table.

Option	Description
Variable	<p>Defines the motion processor parameter to be tracked and stored for the selected Axis. Selecting None disables that trace and any traces that follow.</p> <p>For descriptions of the data available for capture, see Chapter 8 of the <i>Magellan Motion Processor User's Guide</i>.</p>
Axis	Sets the axis to be tracked for the selected Variable.
Value at Cursor	<p>Displays the value under the mouse-activated data probe cursor.</p> <p>For more information about the mouse-activated data probe cursor, refer to Section 5.2.5.</p>
Load button	Loads the previous trace data from memory.
Start button	<p>Starts a new trace.</p> <p>Applies changes made in the Settings dialog box.</p>

**NOTE:** *Trace data is overwritten as soon as a new trace is started.*

#### **Trigger Conditions**

Condition	Sets the conditions that will Start and Stop the trace. Options include:
- Start	
- Stop	<ul style="list-style-type: none"> <li>• Immediate (when start/stop button pressed)</li> <li>• Update</li> <li>• Event status</li> <li>• Activity status</li> <li>• Signal status</li> </ul>
Axis	Sets the axis to which the Start or Stop condition applies.
Bit	<p>For Event Status, Activity Status, and Signal Status Condition, defines the bit that will be the triggering event.</p> <p>For descriptions of the event options, see "Event Status register" in Chapter 7 of the <i>Magellan Motion Processor User's Guide</i>.</p>
State	Sets the state of the bit that will cause a trigger: 0 = off, 1 = on.
Trace Period	The number of cycles to be sampled in a trace period. Changes the time axis scale proportionally.
Trace Mode	Sets the conditions that control the length of the trace:
- One time	<ul style="list-style-type: none"> <li>• One time mode automatically ends the trace when the motion processor's buffer is filled.</li> </ul>
- Rolling buffer	<ul style="list-style-type: none"> <li>• Rolling buffer mode continuously traces data and stores it in the host until the host's virtual memory is exhausted.</li> </ul>



### 5.2.3 The Oscilloscope Control Bars

The oscilloscope controls are located directly above and below its display. The controls are described in the following table.

Option	Function
Start Trace/Stop Trace	Starts and stops the trace. Initiates setting changes.
Show Settings/Hide Settings	Displays the Scope Settings dialog box. <ul style="list-style-type: none"> <li>To display the settings select Show Settings.</li> <li>Click to toggle between Show Settings and Hide Settings.</li> </ul>
Overlay	When checked, lays the traces over one another. <p><i>NOTE: In overlay mode, it is often helpful to disable one or more traces by deselecting the checkboxes above the oscilloscope.</i></p>
Zoom level indicator: + and – buttons	Indicates the zoom level of the trace display in the selected time units (range = 5000/div to 10/div). <ul style="list-style-type: none"> <li>To display more samples, click the + button.</li> <li>To display fewer samples, click the – button.</li> <li>To reset the zoom level to the oscilloscope default, click the zoom level indicator.</li> </ul>
Points	Displays points of reference on the trace. This feature is most useful at high zoom levels, as it allows the motion engineer to differentiate between trace data points and interpolated display values.
Time Axis	Controls the units displayed along the time axis of the oscilloscope display. <p><i>NOTE: The time axis can be changed only when the trace is not running.</i></p>

### 5.2.4 Changing the Oscilloscope Display

Use the options displayed directly above and below the oscilloscope to change the view while the oscilloscope is running

Task	Action
Remove a trace from the oscilloscope	Deselect the trace in the key above the oscilloscope.
Read the y axis scale	Either enlarge the oscilloscope or deselect one or more of the traces from the key above the oscilloscope.

Task	Action
View the traces overlaid on one another	Select Overlay. (Note that in Overlay view, the cycle/count axis labels are not displayed.)  <i>NOTE: In Overlay view, if two or more traces are following the same trajectory, the color of the lower trace will be displayed on the oscilloscope.</i>
Change the zoom	Use the + and – buttons below the oscilloscope.  <i>NOTE: The changing scale is reflected in the bar between the + and – symbols and in the scale of the oscilloscope's time axis.</i>  Mouse alternative: Press SHIFT + the left mouse button and drag the displayed cursor over a range of data from left to right to zoom the display.
Display data points on each trace	Select the Points option. (To remove the data points, deselect the option.)
Change the scale on the Time axis	Select the desired scale from the Time axis box (active only when the trace is not running).

### 5.2.5 Using the Mouse as a Data Probe Cursor

To use the mouse to probe and manipulate the oscilloscope:

Task	Action
Change the zoom	Press SHIFT + the left mouse button and drag the displayed cursor over a range of data from left to right to zoom the display.
View the value of one point on the trace	Position the mouse over the desired point, then press and hold the left mouse button to display the value of the trace beneath the mouse.  <i>NOTE: The value will simultaneously be displayed in the Value at Cursor field of the Scope Settings dialog box.</i>
View the values at each point along the trace	Press and hold the left mouse button and move the mouse across the oscilloscope to display the values at multiple points along the trace.  <i>NOTE: The value will also be displayed in the Value at Cursor field of the Scope Settings dialog box.</i>
Scroll the graph	Press the right mouse button and drag the mouse in the desired direction. The graph will scroll in the direction of the mouse movement.

## 5.2.6 Saving and Printing The Trace Data

To save the trace data, select File/Save from the File menu.

To print the oscilloscope data, select Print from the Pro-Motion File menu to open the Scope Print dialog box. The trace settings currently displayed will be printed at the current zoom level and scroll position.

## 5.2.7 Exporting the Trace Data

To export oscilloscope data, select Export from the Pro-Motion File menu.

Pro-Motion will export all of the trace data from the Scope window to a comma-separated ASCII file format that is compatible with many applications (Figure 5-3). The data file contains one column of data for each trace, with two lines of header data defining the trace variables and units of measure in use.

**NOTE:** *Export Trace is disabled while the oscilloscope is running.*

Sample Time cycles	AX1 Position Error counts	AX1 Commanded Position counts	AX1 Commanded Velocity counts / ms	AX1 Commanded Acceleration counts / ms <sup>2</sup>
0	212	213	-0.99999	0
10	209	210	-0.99999	0
20	207	207	-0.99999	0
30	204	205	-0.99999	0
40	202	202	-0.99999	0
50	199	200	-0.99999	0
60	196	197	-0.99999	0
70	194	195	-0.99999	0
80	191	192	-0.99999	0
90	189	190	-0.99999	0
100	186	187	-0.99999	0

**Figure 5-3:**  
Exported  
trace data

## 5.3 The Status Window



**Figure 5-4:**  
**Status**  
**window**

The Status window allows you to continuously monitor the values of selected motion processor registers. Status tracks the values of up to four axes in tabular form and displays the following data for each axis:

- Commanded position
- Actual position
- Position error
- Capture position
- Active motor command (not available with Pulse & Direction motor type).

The boxes labeled Home, Positive limit, and Negative limit indicate the signal states; those labeled In motion and Settled indicate the activity states.

### 5.3.1 Using the Status Window

The Status window is included in the Normal View. To toggle the Status window open or closed and move it onto the desktop when not in Normal View, click the Status icon on the toolbar (or select View/Status on the menu bar).

## 5.4 The Drive Status Window (ION Only)

The Drive Status window permits quick access to amplifier information for the currently active drive.

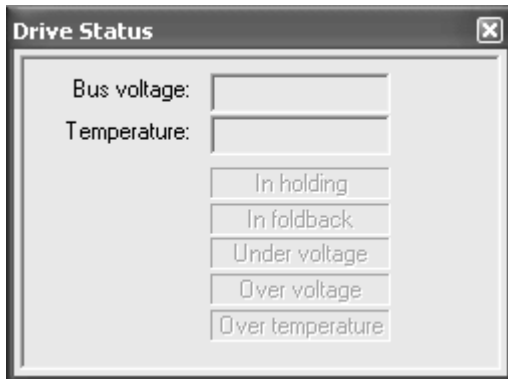

**Figure 5-5:**  
**Drive Status**  
**window (ION**  
**only)**

In addition to showing the present voltage and temperature, the window indicates whether the drive is in any of the following states:

- In holding
- In foldback
- Undervoltage
- Overvoltage
- Overtemperature

*This page intentionally left blank.*

## *In This Chapter*

- ▶ Introduction
- ▶ Encoder Setup
- ▶ Motor Signal Output Setup
- ▶ Phase Initiation Setup
- ▶ Servo Setup
- ▶ Position Capture Signal Setup
- ▶ Positive/Negative Limit Switch Tests

## 6.1 Introduction to the Axis Wizard

The Axis Wizard guides you through the process of setting up and testing motor connections and parameters for an axis. The Wizard consists of a series of setup pages followed by test pages that allow you to verify and adjust individual parts of the setup as you go.

This chapter contains information about the pages of the Axis Wizard and instructions for each one. Once the axis has been set up, further tuning can be done using the Control module (For instructions, refer to Chapter 5 of this User's Guide.)

The series of pages you will see in the Wizard will vary depending on the type of motor and the variables you select along the way.

As a safety feature, selecting Cancel (or pressing Escape) at any time in the Axis Wizard will exit the Wizard as well as disable the motor output. If the Axis Wizard is completed without canceling (i.e., the Finish button is clicked), the motor output will remain enabled.

## 6.2 Encoder Setup

The encoder setup defines the type of position feedback device (encoder) that is connected to the motor. Once the encoder is set up, it is used to verify that the direction of the motor is set correctly.

## 6.2.1 Encoder Test

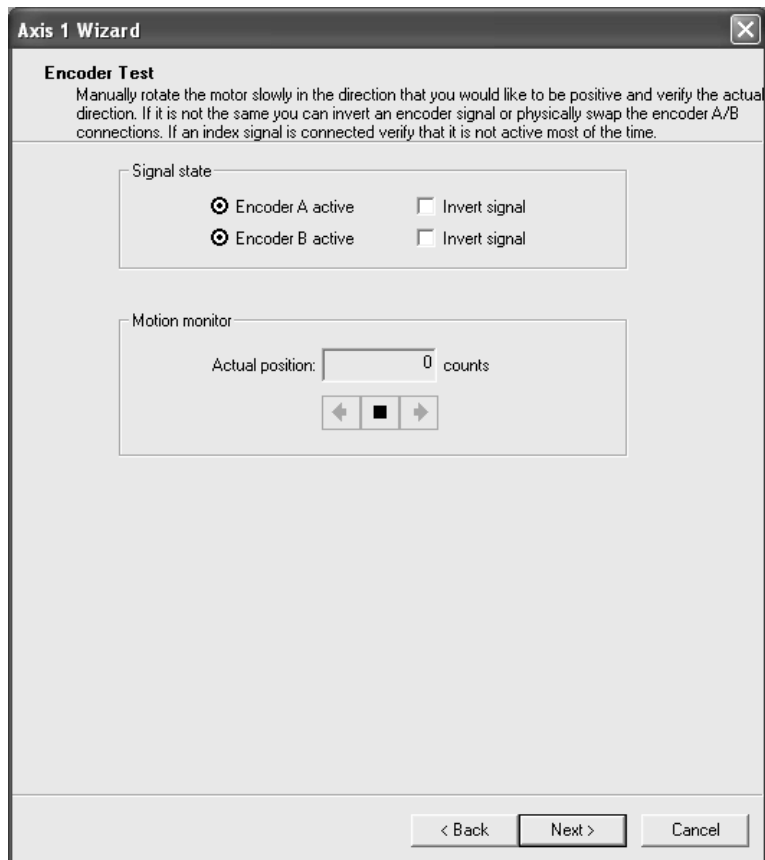

**Figure 6-1:**  
**Encoder test**

To verify that the incremental encoder is counting in the right direction:

- 1 Manually rotate the motor slowly in the direction selected to be positive, and verify the direction in the Motion monitor, which shows both the direction of the motion (+ or -) and the actual position of the motor.
- 2 If the Actual position is going in the wrong direction, either Invert one of the signals or physically swap the connections.



## 6.3 Microstepping Motor Settings

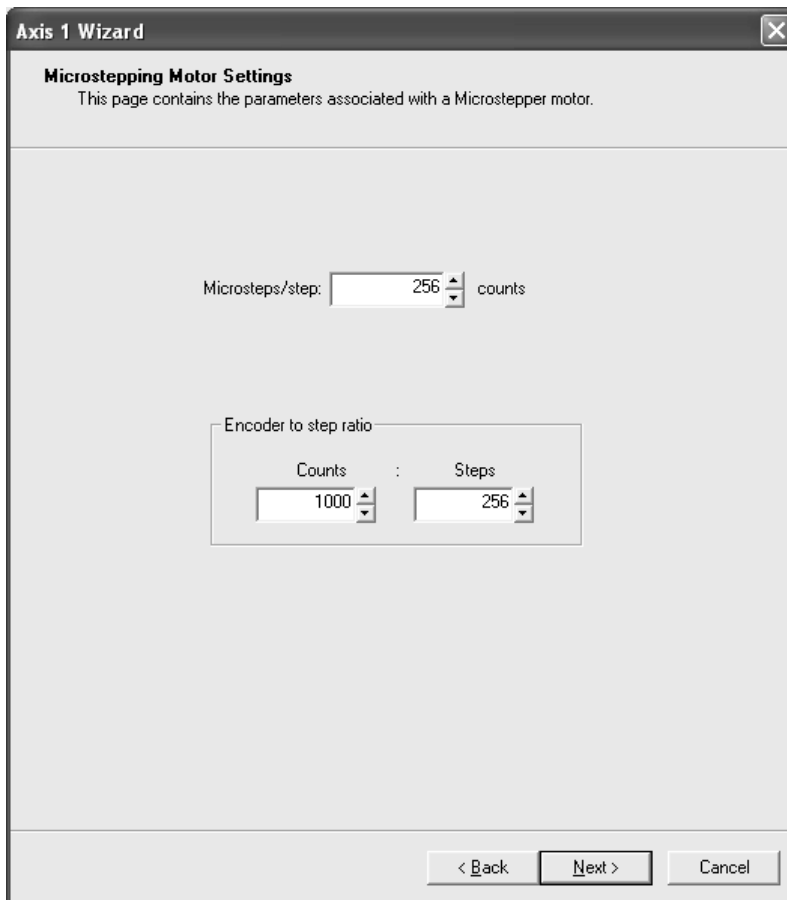

The screenshot shows a dialog box titled "Axis 1 Wizard" with a close button in the top right corner. The main title is "Microstepping Motor Settings" and the subtitle is "This page contains the parameters associated with a Microstepper motor." Below the subtitle, there is a label "Microsteps/step:" followed by a spin box containing the value "256" and the text "counts". Below this, there is a label "Encoder to step ratio" followed by a sub-dialog box. This sub-dialog box has two labels: "Counts" and "Steps", separated by a colon. Under "Counts" is a spin box with the value "1000", and under "Steps" is a spin box with the value "256". At the bottom of the main dialog box, there are three buttons: "< Back", "Next >", and "Cancel".

**Figure 6-2:**  
**Microstepping  
motor settings**

## 6.4 Motor Output Test

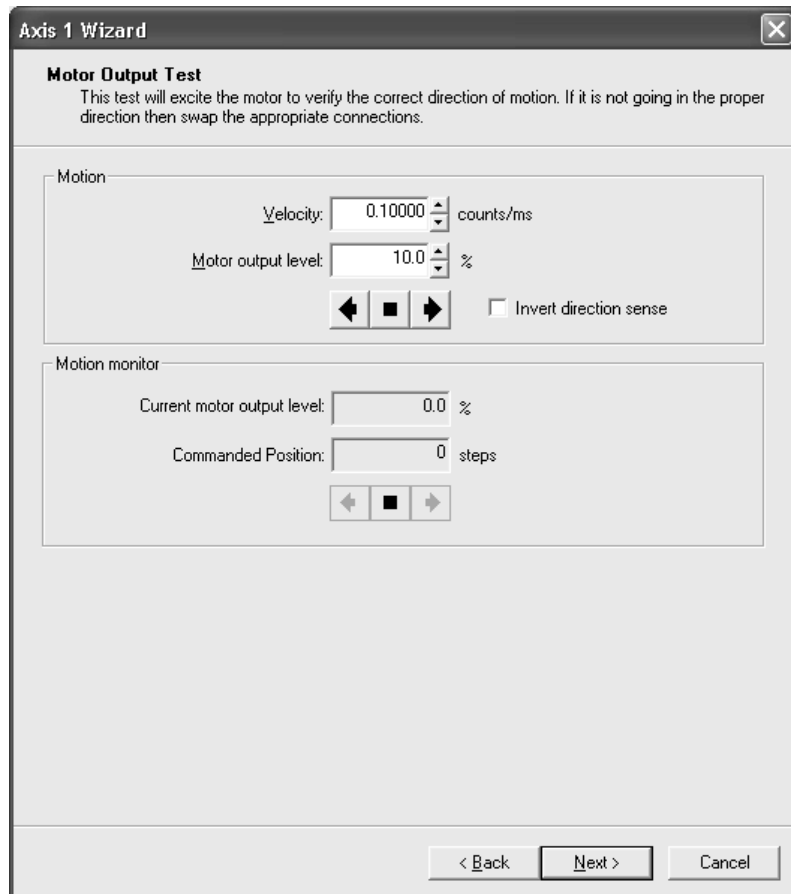

**Figure 6-3:**  
**Motor output test**

The Motor Output test excites the motor to verify that the motor is moving in the correct direction.

To run the test:

- 1 Verify that the amp is enabled.
- 2 Enter the minimum velocity and/or motor output level (depending on motor type) required to make the motor move.
- 3 Click one of the directional arrows and verify correct motor operation.

Action	Procedure
To stop the motion	Click the square between the forward and back arrows
To reverse the motion	Click the opposite arrow
To change the Motion settings	<ul style="list-style-type: none"> <li>• Stop the motion by clicking the square between the arrows</li> <li>• Change the Velocity and/or Motor output level</li> <li>• Click one of the directional arrows to re-start the motion.</li> </ul>

- 4 If the direction of the motion is not correct, select the Invert direction sense option and repeat Step 2 to verify the change.

### 6.4.1 Algorithmic Phase Initialization Method (Brushless DC Only)

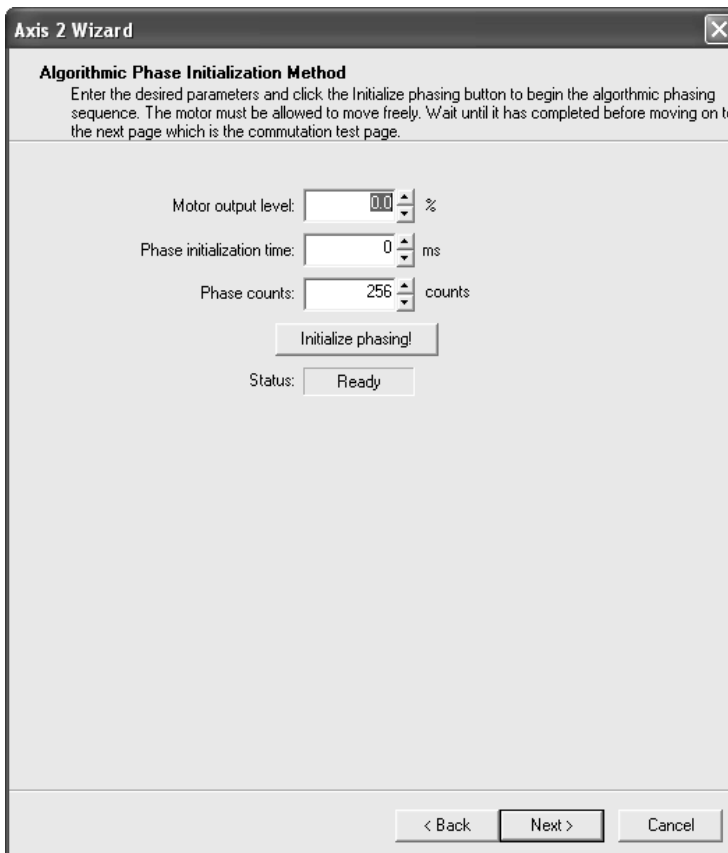
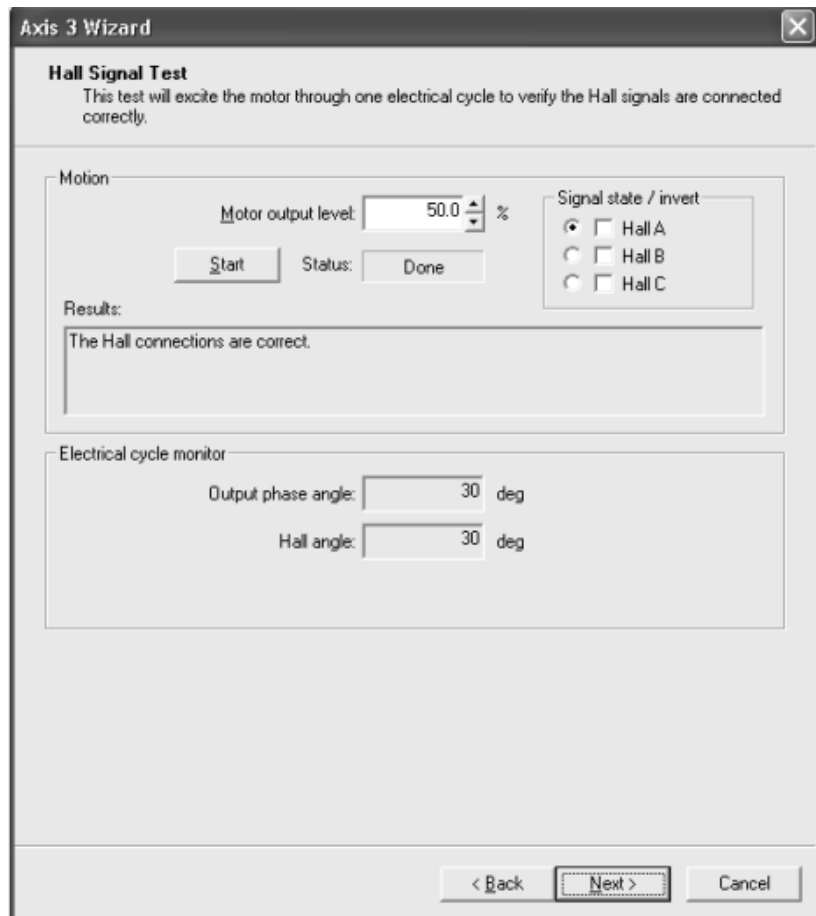

**Figure 6-4:**  
Algorithmic phase initialization method (brushless DC only)

To initialize the Algorithmic phasing sequence:

- 1 Enter the desired Phase initialization time (2–4 seconds).
- 2 Click the Initialize phasing button. The motor will move slightly. When it stops moving, the algorithmic phase is initiated, and the Status message displays **Done**.
- 3 Click Next to display the Commutation Test page.

### 6.4.2 Hall Signal Test (Brushless DC Only)



**Figure 6-5:**  
Hall signal test  
(brushless DC  
only)

To verify that the Hall signals are connected properly:

- 1 Enter a sufficient motor output level required to move the motor and hold it at a specific phase angle.
- 2 Click Start. The motor will move through one electrical cycle over 10 seconds.
- 3 Observe the results in the Results window.

### 6.4.3 Commutation Test (Brushless DC Only)

The Commutation test will excite the motor in open loop mode to verify commutation. If the motor locks up, check the motor connections and phase counts (if applicable) and re-run the Wizard.

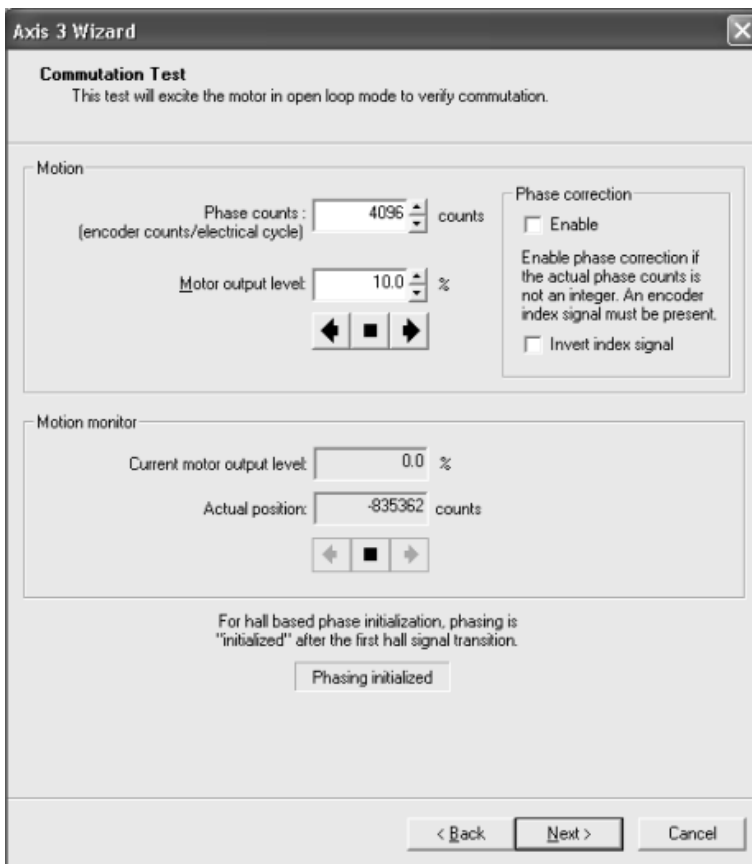
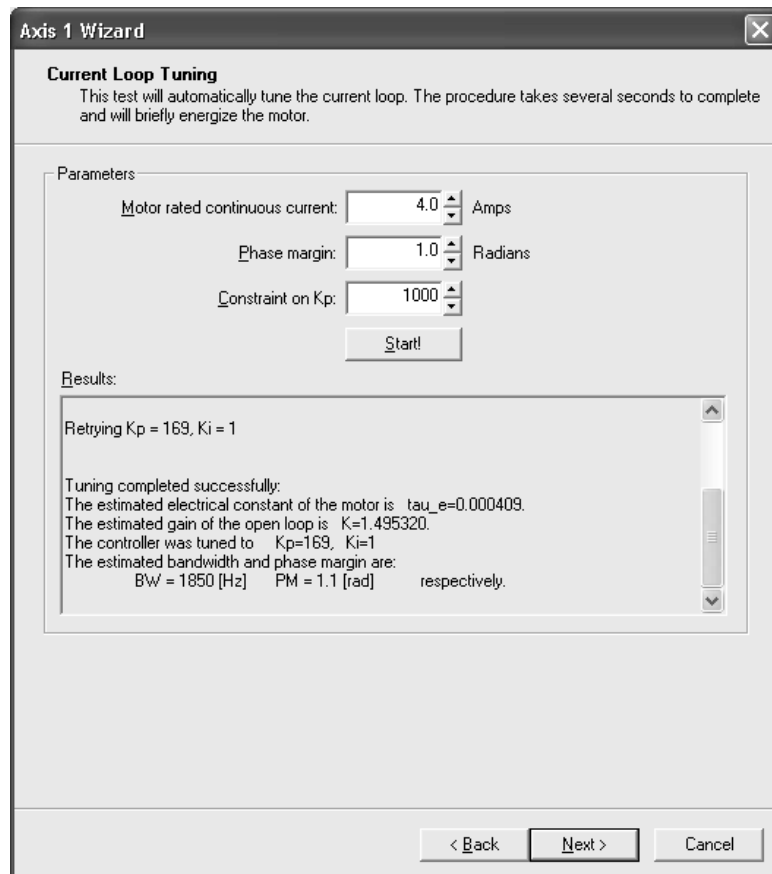

Figure 6-6:  
Commutation  
test (brushless  
DC only)

To run the Commutation test:

- 1 If using an encoder, enter the desired number of encoder counts per cycle in the Phase counts box.
- 2 Enter the minimum value required to cause motion in the Motor output level box.
- 3 Click the forward or back arrow to excite the motor.
- 4 Verify that the motor is moving smoothly in the direction of the selected arrow.

### 6.4.4 Current Loop Tuning (ION Only)



**Figure 6-7:**  
Current loop  
tuning (ION  
only)

The current loop tuning page automatically determines the current loop (PI) settings for your motor.

The ION utilizes a digital current loop to control the current through the windings of the motor.

To run the current loop auto-tuning procedure

- 1 Use the up/down arrows to enter the amps for the Motor's rated continuous current, desired loop's Phase margin, and Constraint on the proportional gain ( $K_p$ ).
- 2 Click Start! The procedure takes approximately 30–60 seconds to complete, during which the shaft may move and audible tones may be heard .
- 3 In the Results window, verify that the tuning completed successfully.

If the tuning result is too aggressive or noisy try to:

- 1 Increase the phase margin (maximum value is 1.6 rad)
- 2 Decrease the constraint on the proportional gain ( $K_p$ ).

## 6.5 Servo Loop Tuning (Servo Motors Only)

The servo loop tuning page is used to set up the servo loop parameters. You may either do this manually by trial and error using steps 2 and 3, or you may use the built-in auto-tuning procedure in step 1.

The servo loop settings are used to correct the position of the motor while it is moving and when it is at rest. Accurate settings are important for stable and reliable motion.

**Figure 6-8:**  
Servo loop  
tuning

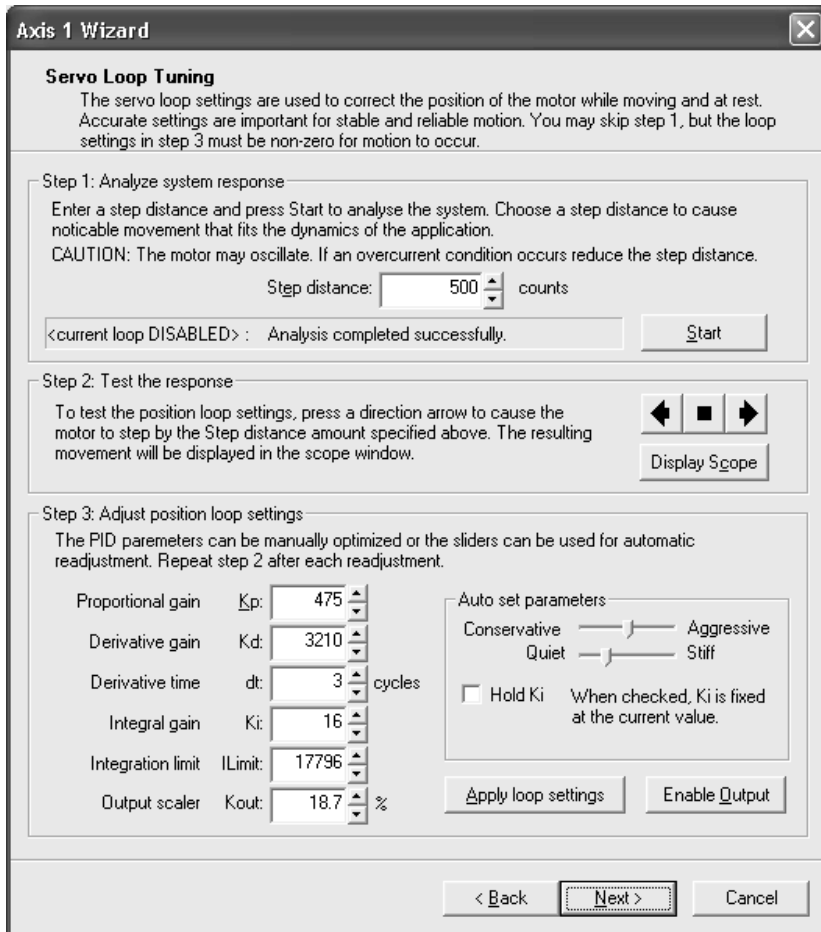

### 6.5.1 Auto-tuning

To use the auto-tuning procedure:

- 1 Enter a step distance that will cause noticeable movement, keeping in mind that the motor will oscillate with a magnitude of the step distance. A value less than 1/4 rotation should be sufficient.
- 2 Press Start and monitor the status line displaying the auto-tune procedure progress.



The procedure goes through the following steps:

- a Evaluation of the system's noise
- b Relay testing
- c Verification

In the noise evaluation step, the point where the motor command overcomes the shaft's friction is sought together with a value for the derivative term,  $K_d$ , for which the noise level is "reasonable."

The motor is then set to oscillate in a series of relay tests, which may take 30–90 sec. The amplitude of these oscillations should correspond to the step distance entered in step 1. If excessive oscillations occur use the Stop or Cancel buttons to terminate immediately the procedure.

On the successful completion of the relay-testing step, a new set of servo loop parameters is shown and the "Auto set parameters" window appears. The new set of parameters is not applied unless the Apply loop setting button is pressed and the motor output is disabled. If at this point the output is enabled, the previous (to the auto-tuning) servo loop parameters will take effect.

The first time the Apply loop parameters button is pressed, the procedure goes through a short (less than 10 seconds) verification step in which oscillations are being detected.

### 3 Test and adjust the loop setting.

The servo-tuning page provides a step response generator to test the servo loop's response. Use the Display scope button to display the responses of the position error, integral component, and motor command.

Use the Auto set parameters window to adjust the loop's setting and response. The Auto set parameters window provides the following controls:

1. Aggressiveness slider
2. Stiffness slider
3. Hold  $K_i$  check box.

To adjust the loop's setting:

1. Use the stiffness slider to determine a tradeoff between the amount of noise and stiffness of the motor. If the noise is too high try increasing the Derivative time ( $dT$ ). The auto-tuner will adjust the value for the Derivative gain ( $K_d$ ) automatically.

2. When the motor's stiffness versus noise is satisfactory, use the Aggressiveness slider to determine the loop's stability versus dynamics.

Remember to use the Apply loop settings button to apply the changes and to check the step response of the motor. In cases where the automatic setting doesn't set the Integral gain properly use Hold Ki checkbox and set a new value for Ki. The other loop's settings will be changed accordingly to satisfy the required value for Ki.

In case the auto-tuner doesn't come up with a satisfactory set of parameters, set the loop parameters manually, as described in the following subsection.

## 6.5.2 Adjusting the Servo Loop Parameters Manually

To set the preliminary servo loop parameters:

- 1 Initially set the Proportional gain ( $K_p$ ) and Derivative gain ( $K_d$ ) parameters to small values.
- 2 Enter a step distance in encoder counts (typically at least a 1/4 motor rotation). Too large a step distance may cause an overcurrent condition.
- 3 Select the Display Scope button to open the oscilloscope.
- 4 Click one of the direction arrows on the Servo Setup page to jog the motor. The motor will move by the selected step distance, and the resulting movement will be displayed in the oscilloscope (Scope) window.
- 5 Check the oscilloscope to verify the servo loop response and that the motor is moving in the expected direction.
- 6 Increase  $K_p$  and  $K_d$  until the motion is stable and the actual position follows the commanded position as closely as possible with no overshoot.
- 7 If the motor starts oscillating, reduce the  $K_p$ .
- 8 When  $K_p$  and  $K_d$  provide stable and responsive motion, set the Integral gain ( $I$ ). To close any remaining position error after the move is complete, set the integration limit.

For more in-depth manual servo tuning you may use the Tuning view in the View menu.

For more information about

- The servo setup, refer to Section 4.4.
- Utilizing the oscilloscope, refer to Section 5.2.

## 6.6 Encoder Index Signal Test

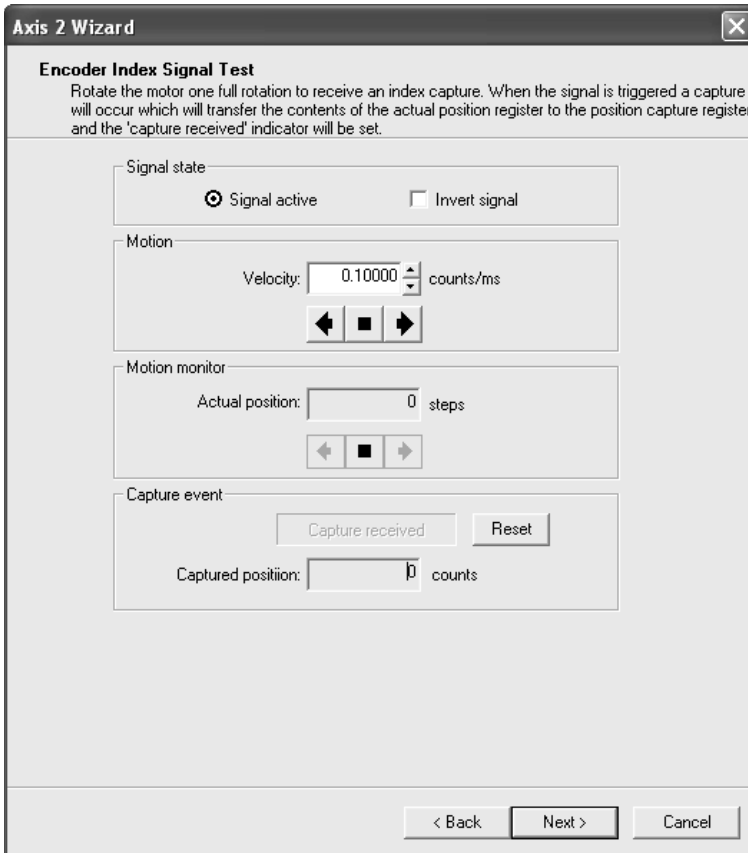

**Figure 6-9:**  
Encoder  
Index signal  
test

The Encoder Index Signal test verifies that the index signal is being received. To run the test, turn the motor at least one full rotation to trigger the signal and receive an Index capture.

**NOTE:** You can either rotate the motor manually or use the velocity and direction controls in the Motion box.

When the signal is triggered, a position capture will occur and the following information will be displayed in the Capture event box:

- The Capture received indicator (hi-lited).
- In the Captured position field, the contents of the position register (in counts).

If a capture occurs more than once within one rotation, you may need to invert the signal sense.

### 6.6.1 Capture Input Signal Test

If the position capture signal is not set to index, this page will be displayed instead. The Capture Input Signal test uses the selected capture input signal to verify connectivity to the processor.

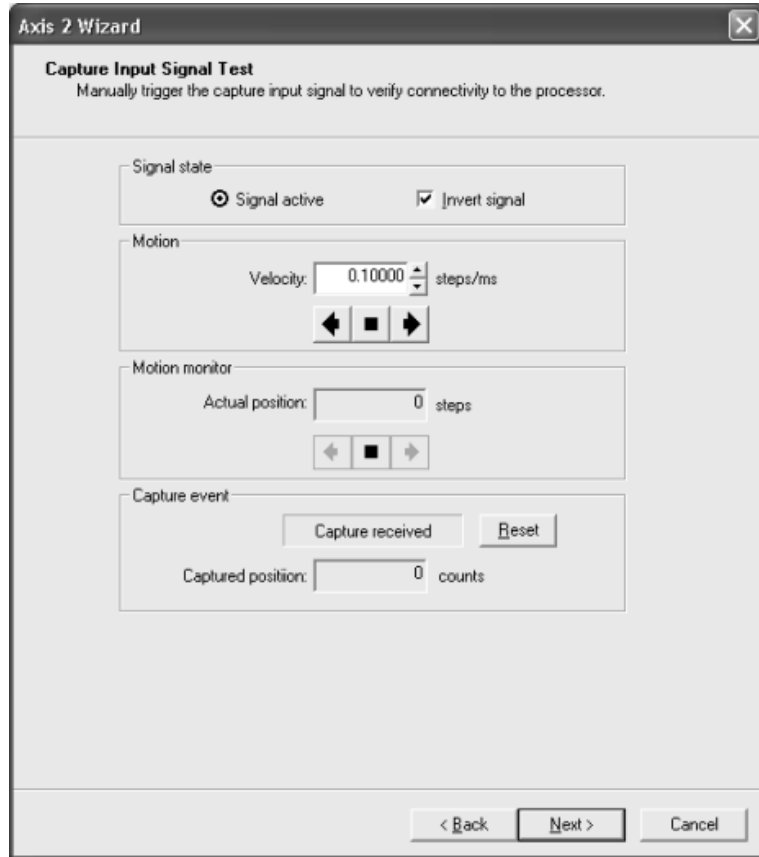

Figure 6-10:  
Capture Input  
signal test

To test the capture signal:

- 1 Verify that the signal active indicator properly reflects the state of the signal.
- 2 When the signal becomes active, it will trigger a capture. The message **Capture received** is displayed in the Capture event box, confirming that the capture occurred.
- 3 To run the test again click the **Reset** button to re-arm the trigger.

## 6.7 Positive/Negative Limit Switch Tests

If you are using positive and/or negative limit switches, run the Limit Switch tests to verify that the limit switches are working.

The Positive Limit Switch Signal test moves the motor in the positive direction to test the positive limit switch signal. The Negative Limit Switch Signal test moves the motor in the negative direction to test the negative limit switch signal.

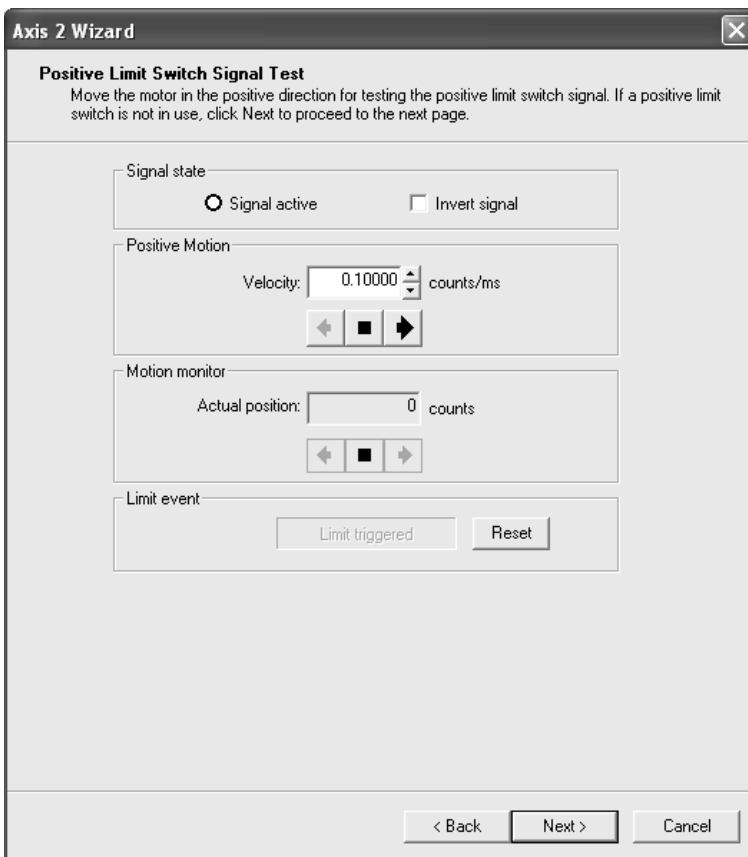

**Figure 6-11:**  
Positive Limit  
switch signal  
test

To test the positive or negative limit switch:

**NOTE:** *If you are not using a positive limit switch, click Next to continue with the Negative Limit Switch test.*

- 1 Trigger the appropriate limit switch manually or by moving the axis into the switch by clicking the appropriate direction arrow to start motion.
- 2 When the positive/negative limit is reached, the “Limit triggered” indicator is displayed in the Limit event box.
- 3 If the Signal state shows Active when the limit switch is not triggered, invert the signal and run the test again.

## *In This Section*

- ▶ The Command Window
- ▶ The Monitor Window

## 7.1 The Command Window

The Command window (Figure 7-1) is an alternative, lower-level method for controlling the motion processor. The window has a DOS command line style interface, with the command prompt (>), and accepts all of the motion processor commands. This window is provided for backwards compatibility to previous versions of Pro-Motion.

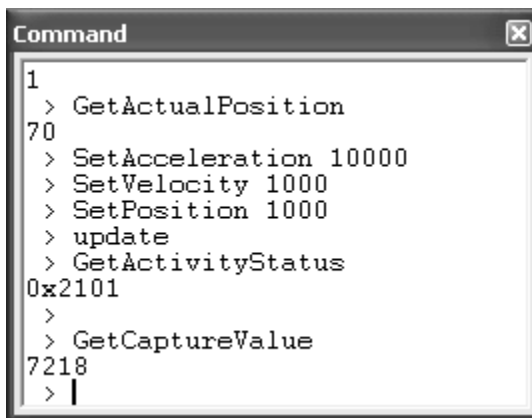

```
Command
1
> GetActualPosition
70
> SetAcceleration 10000
> SetVelocity 1000
> SetPosition 1000
> update
> GetActivityStatus
0x2101
>
> GetCaptureValue
7218
> |
```

**Figure 7-1:**  
Command window

### 7.1.1 Using the Command Window

To use the Command window:

- 1 Select the Command icon from the tool bar (or View/Command from the menu bar) to open the Command window.
- 2 Type the desired sequence of commands, one command per line. Or, if you prefer, use the Select a Command utility:
  - Press TAB at the prompt to open the Select a Command window (Figure 7-2).
  - Scroll through the list to locate the desired command.

**NOTE:** *If you type the first few characters of a command at the prompt, then press Tab, the Command window scrolls to the commands that begin with those characters.*

**Figure 7-2:**  
**Sample**  
**command**  
**session**

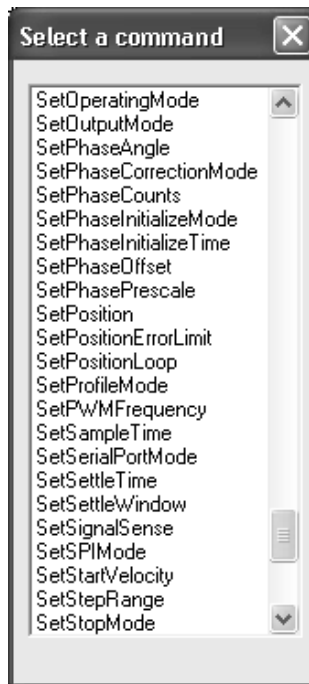

- Highlight the command, then press Enter. The selected command appears at the Command prompt (>) and the Select a Command window closes.
- Enter any required parameters for that command.
- Press Enter again to send the command.

Commands entered in the Command window will be retained until the current Pro-Motion session is closed.

### 7.1.2 Command Structure

The sequence in Figure 7-1 shows a typical command session.

The Command settings are not case-sensitive, so commands can be entered in any combination of upper and lower case characters.

As illustrated in Figure 7-1, commands are entered as a sequence of command name followed by up to three numeric parameters. The parameters can represent a single 16-bit word of data or a 32-bit double word of data, depending on the requirements of the particular command, as shown in the *Magellan Motion Processor Programmer's Command Reference*.



## Numeric format

The Command window accepts numeric parameters in either decimal or hexadecimal format. Pre-fixing a numeric parameter with “0x” enters that number using hexadecimal format. For example:

```
> SetAcceleration 0xA
```

sets the acceleration to 10 (decimal). When a numeric parameter is entered without any prefix, it is assumed to be in decimal format.

## Examples of commands

Some examples of command structure are shown below. For a full list of commands and their required parameters, refer to *The Magellan Programmer's Command Reference*.

### Example 1:

In the command

```
> SetBreakpointValue 0 1000
```

the first parameter represents a 16-bit word that contains the selected breakpoint number (0 or 1), and the second parameter represents a 32-bit word that contains the breakpoint value.

In this example, **0** selects the breakpoint number for which the value is set.

### Example 2:

All of the **Get** commands display the value returned by the chipset. For example, the command

```
> GetEventStatus
```

returns the value in hexadecimal format.

```
0x0000
```

### Example 3:

Some **Get** commands require a parameter for selecting the desired value. For example:

```
> GetBreakpointValue 0
```

in which **0** selects the breakpoint number for which the value is retrieved.

## 7.2 The Monitor Window

The Monitor window (Figure 7-3) displays the stream of commands sent to the motion processor. Like all windows in Pro-Motion, the Monitor can be docked on the desktop and re-sized to display as much of the command stream as desired.

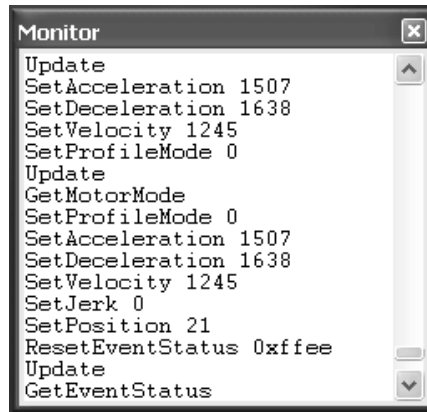

**Figure 7-3:**  
**Sample**  
**monitor view**

To use the Monitor:

- 1 Select the Monitor icon on the toolbar:
- 2 Use the scroll bar to scroll through the command history.
- 3 To monitor only Set commands, right-click in the window and select “filter ‘Gets.’”
- 4 To save the contents of the monitor window buffer to a file, right-click on the window and select Save As.

**NOTE:** *When the window is resized, the display scrolls to the end of the command stream. Use the scroll bar to view earlier commands in the stream.*

---

**For additional information, or for technical assistance,  
please contact PMD at (781) 674-9860.**

**You may also e-mail your request to [support@pmdcorp.com](mailto:support@pmdcorp.com)**

**Visit our website at <http://www.pmdcorp.com>**

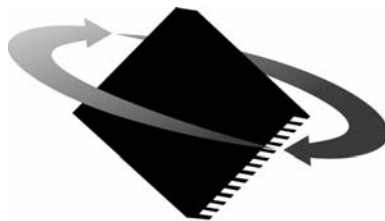

**P M D**

**Performance Motion Devices  
55 Old Bedford Rd.  
Lincoln, MA 01773**