

MS/Standard insert arrangements

Insert Arrangement	Service Rating	Total Contacts	Contact Size				
			0	4	8	12	16
8S-1	A	1					1
10S-2	A	1					1
10SL-3	A	3					3
10SL-4	A	2					2
12S-1	A	2					2
12S-2	A	2					2
12S-3	A	2					2
12S-4	D	1					1
12-5	D	1				1	
14S-1**	A	3					3
14S-2	Inst.	4					4
14-3	A	1			1		
14S-5	Inst.	5					5
14S-6	Inst.	6					6
14S-7	A	3					3
14S-9**	A	2					2
14S-10	Inst.	4					4
14S-11	Inst.	4					4
14S-12	A	3					3
14S-13	A	3					3
16S-1	A	7					7
16-2*	E	1				1	
16S-3*	B	1					1
16S-4*	D	2					2
16-7*	A	3			1		2
16S-8	A	5					5
16-9	A	4				2	2
16-10	A	3				3	
16-11	A	2				2	
16-12	A	1		1			
16-13	A	2				2	
18-1	A/Inst.	10					10
18-4	D	4					4
18-5	D	3				2	1
18-6*	D	1		1			
18-7*	B	1			1		
18-8	A	8				1	7
18-9	Inst.	7				2	5
18-10**	A	4				4	
18-11	A	5				5	
18-12*	A	6					6
18-13	A	4			1	3	
18-14*	A	2		1			1
18-15*	A	4				4	
18-16*	C	1				1	
18-17	Inst.	7				2	5
18-18	Inst.	7				2	5
18-19**	A	10					10
18-22**	D	3					3

Insert Arrangement	Service Rating	Total Contacts	Contact Size				
			0	4	8	12	16
18-23	A/Inst.	10					10
18-24	A/Inst.	10					10
18-27	D	3				2	1
18-28	D	3				2	1
20-2	D	1	1				
20-4	D	4				4	
20-7	D/A	8					8
20-8	Inst.	6			2		4
20-9*	D/A	8				1	7
20-14	A	5			2	3	
20-15	A	7				7	
20-16	A	9				2	7
20-17	A	6				5	1
20-18	A	9				3	6
20-19	A	3			3		
20-21	A	9				1	8
20-22	A	6			3		3
20-24	A	4			2		2
20-27	A	14					14
20-29	A	17					17
20-32	D/A	8					8
20-33	A	11					11
22-2	D	3			3		
22-4**	A	4			2	2	
22-5	D	6				2	4
22-6*	D	3			2		1
22-7*	E	1	1				
22-9*	E	3				3	
22-10*	E	4					4
22-11*	B	2					2
22-12*	D	5			2		3
22-14	A	19					19
22-15*	E/A	6				5	1
22-17*	D/A	9				1	8
22-18*	D/A	8					8
22-19	A	14					14
22-21	A	3	1				2
22-22	A	4			4		
22-23	D/A	8				8	
22-27*	D/A	9			1		8
22-30	A	19					19
22-32	D	6				2	4
22-36*	D/A	8				8	
24-1**	D	2	1			1	
24-2	D	7				7	
24-4*	D	4	1				3
24-5**	A	16					16
24-6*	D/A	8				8	

* Consult Amphenol, Sidney, NY for availability

** Inactive for new design

MS/Standard insert arrangements

Insert Arrangement	Service Rating	Total Contacts	Contact Size				
			0	4	8	12	16
24-7	A	16				2	14
24-10	A	7			7		
24-11	A	9			3	6	
24-12	A	5		2		3	
24-15	A	16					16
24-16*	D/A	7			1	3	3
24-20	D	11				2	9
24-21*	D	10			1		9
24-22	D	4			4		
24-24	A	16					16
24-27*	E	7					7
24-28	Inst.	24					24
24-80*	Inst.	23					23
28-1	D/A	9			3	6	
28-2	D	14				2	12
28-3*	E	3			3		
28-4*	E/D	9				2	7
28-5*	D	5		2		1	2
28-8*	E/D/A	12				2	10
28-9	D	12				6	6
28-10	D/A	7		2	2	3	
28-11	A	22				4	18
28-12	A	26					26
28-13	A	26					26
28-15	A	35					35
28-16*	A	20					20
28-17	B/D/A	15					15
28-18*	C/D/A/Inst.	12					12
28-19*	B/D/A	10				4	6
28-20	A	14				10	4
28-21	A	37					37
28-22	D	6		3			3
32-1	E/D	5	2			3	
32-2*	E	5		3			2
32-3*	D	9	1	2		2	4
32-6	A	23		2	3	2	16
32-7	Inst./A	35				7	28
32-9	D	14		2			12
32-13	D	23				5	18
32-15	D	8	2			6	
32-16	A	23		2	3	2	16
32-17	D	4		4			
32-19*	E/D	5	2			3	
32-20	A	23		2	3	2	16

Insert Arrangement	Service Rating	Total Contacts	Contact Size				
			0	4	8	12	16
32-22*	A	54					54
32-63	D	5		5			
32-73	A	46					46
36-3	D	6	3			3	
36-5	A	4	4				
36-6	A	6	2	4			
36-7	A	47				7	40
36-8	A	47				1	46
36-9	A	31		1	2	14	14
36-10	A	48					48
36-11	A	48					48
36-12	A	48					48
36-15	D/A	35					35
36-16	A	47				7	40
36-17	A	47				7	40
36-18	A	31		1	2	14	14
36-21	A	31		1	2	14	14
36-52	A	52					52
36-66*	A	56				4	52
40-1	D	30				6	24
40-2*	D	23					23
40-3*	D	23		1		4	18
40-4*	D	23		2	3	2	16
40-5*	A	15	3	2	4	6	
40-6*	D	26	1			1	24
40-7*	A/D	22	2			2	18
40-9	A	47			1	22	24
40-10*	A	29		4	9		16
40-11*	D	25	1	1	1	4	18
40-56*	A	85					85
40-62*	A	60					60

* Consult Amphenol, Sidney, NY for availability

** Inactive for new design

MS/Standard insert alternate positioning

To avoid cross-plugging problems in applications requiring the use of more than one connector of the same size and arrangement, alternate rotations are available as indicated in the accompanying charts.

As shown in the diagram below, the front face of the pin insert is rotated within the shell in a clockwise direction from the normal shell key. The socket insert would be rotated counter-clockwise the same number of degrees in respect to the normal shell key.

The charts give the W, X, Y, Z positions for the alternate rotations available for the insert arrangements of the rear release MIL-DTL-5015 series of connectors. If an insert arrangement number is not given, then there is no available alternate rotation for that pattern.

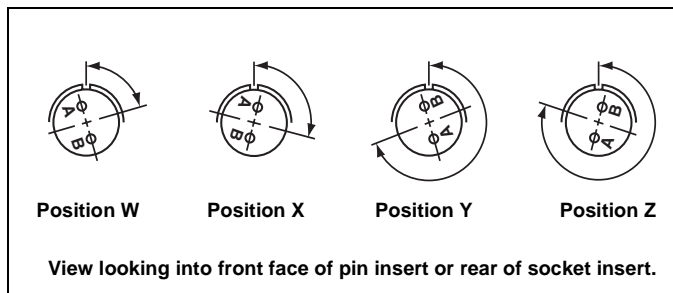

The following insert arrangements have the same alternate insert rotations for W, X, Y and Z, which are:

Degrees			
W	X	Y	Z
80	110	250	280

16-7	20-22	24-4	28-4	28-21	40-3
18-5	22-6	24-5	28-8	32-1	40-4
18-9	22-12	24-6	28-9	32-3	40-5
18-13	22-14	24-7	28-10	32-6	40-6
18-14	22-15	24-12	28-11	32-9	40-7
20-7	22-17	24-16	28-15	32-13	40-11
20-8	22-18	24-20	28-16	32-22	
20-9	22-19	24-21	28-17	36-7	
20-14	22-21	24-28	28-19	36-8	
20-16	24-1	28-1	28-20	40-2	

Insert Arrangement	Degrees			
	W	X	Y	Z
12S-3	70	145	215	290
14S-2	-	120	240	-
14S-5	-	110	-	-
14S-7	90	180	270	-
14S-9	70	145	215	290
16S-1	80	-	-	280
16S-4	35	110	250	325
16S-8	-	170	265	-
16-9	35	110	250	325
16-10	90	180	270	-
16-11	35	110	250	325
16-13	35	110	250	325
18-1	70	145	215	290
18-4	35	110	250	325
18-8	70	-	-	290
18-10	-	120	240	-
18-11	-	170	265	-
18-12	80	-	-	280
18-15	-	120	240	-
18-19	-	120	240	-
18-22	70	145	215	290
20-4	45	110	250	-
20-15	80	-	-	280

Insert Arrangement	Degrees			
	W	X	Y	Z
20-17	90	180	270	-
20-18	35	110	250	325
20-19	90	180	270	-
20-21	35	110	250	325
20-24	35	110	250	325
20-27	35	110	250	325
20-29	80	-	-	280
22-2	70	145	215	290
22-4	35	110	250	325
22-5	35	110	250	325
22-9	70	145	215	290
22-10	35	110	250	325
22-11	35	110	250	325
22-22	-	110	250	-
22-23	35	-	250	-
22-27	80	-	250	280
22-36	90	-	270	-
24-2	80	-	-	280
24-10	80	-	-	280
24-11	35	110	250	325
24-22	45	110	250	-
24-27	80	-	-	280
24-80	35	145	240	300

Insert Arrangement	Degrees			
	W	X	Y	Z
28-2	35	110	250	325
28-3	70	145	215	290
28-5	35	110	250	325
28-12	90	180	270	-
28-18	70	145	215	290
28-22	70	145	215	290
32-2	70	145	215	290
32-7	80	125	235	280
32-15	35	110	250	280
32-17	45	110	250	-
32-73	36	-	-	-
36-3	70	145	215	290
36-5	-	120	240	-
36-6	35	110	250	325
36-9	80	125	235	280
36-10	80	125	235	280
36-15	60	125	245	305
36-52	72	144	216	288
36-66	110	250	260	280
40-1	65	130	235	300
40-9	65	125	255	310
40-10	65	125	255	310
40-56	72	144	216	288
40-62	30	130	220	290

MS/Standard contact arrangements

front face of pin insert or rear face of socket insert illustrated

Insert Arrangement	8S-1	10S-2	10SL-3	10SL-4	12S-1	12S-2	12S-3
Service Rating	A	A	A***	A	A	A	A
Number of Contacts	1	1	3	2	2	2	2
Contact Size	16	16	16	16	16	16	16

Insert Arrangement	12S-4	12-5	14S-1**	14S-2	14-3	14S-5	14S-6
Service Rating	D	D	A	Inst.	A	Inst.	Inst.
Number of Contacts	1	1	3	4	1	5	6
Contact Size	16	12	16	16	8	16	16

Insert Arrangement	14S-7	14S-9**	14S-10	14S-11	14S-12	14S-13
Service Rating	A	A	Inst.	Inst.	A	A
Number of Contacts	3	2	4	4	3	3
Contact Size	16	16	16	16	16	16

Insert Arrangement	16S-1	16-2*	16S-3*	16S-4*	16-7*	16S-8
Service Rating	A	E	B	D	A	A
Number of Contacts	7	1	1	2	1 2	5
Contact Size	16	12	16	16	8 16	16

* Consult Amphenol, Sidney, NY for availability.

** Inactive for new design

*** Service rating Inst. Class K

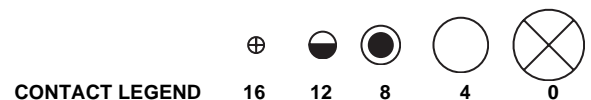

MS/Standard contact arrangements

front face of pin insert or rear face of socket insert illustrated

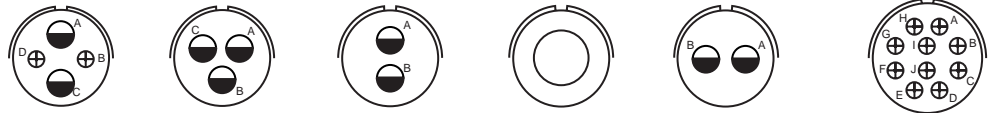

Insert Arrangement	16-9	16-10	16-11	16-12	16-13	18-1
Service Rating	A	A	A	A	A	B, C, F, G = A; Bal. = Inst.
Number of Contacts	2 2	3	2	1	2††	10
Contact Size	12 16	12	12	4	12	16



Insert Arrangement	18-4	18-5	18-6*	18-7*	18-8	18-9
Service Rating	D	D	D	B	A	Inst.
Number of Contacts	4	2 1	1	1	1 7	2 5
Contact Size	16	12 16	4	8	12 16	12 16

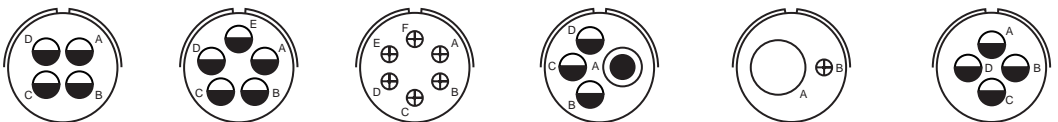

Insert Arrangement	18-10**	18-11	18-12*	18-13	18-14*	18-15*
Service Rating	A	A	A	A	A	A
Number of Contacts	4	5	6	1 3	1 1	4††
Contact Size	12	12	16	8 12	4 16	12

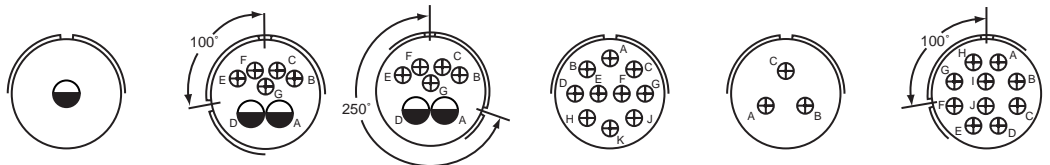

Insert Arrangement	18-16*	18-17	18-18	18-19**	18-22**	18-23
Service Rating	C	Inst.	Inst.	A	D	B, C, F, G = A; Bal. = Inst.
Number of Contacts	1	2 5	2 5	10	3	10
Contact Size	12	12 16	12 16	16	16	16

* Consult Amphenol, Sidney, NY for availability.
 ** Inactive for new design
 † one alumel contact and one chromel contact
 †† A, C = Iron; B, D = Constantan

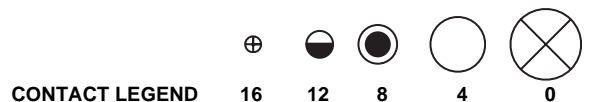

MS/Standard contact arrangements

front face of pin insert or rear face of socket insert illustrated

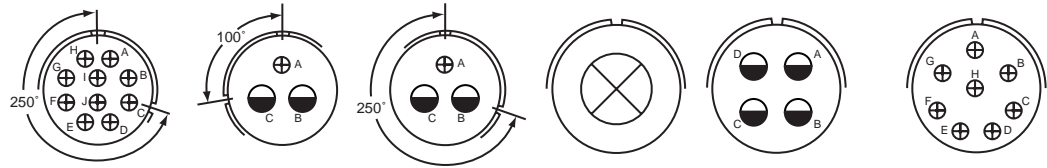

Insert Arrangement	18-24	18-27	18-28	20-2	20-4	20-7
Service Rating	B, C, F, G = A; Bal. = Inst.	D	D	D	D	A, B, G, H = D; C, D, E, F = A
Number of Contacts	10	2 1	2 1	1	4	8
Contact Size	16	12 16	12 16	0	12	16

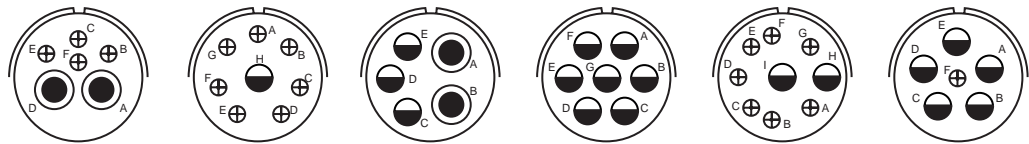

Insert Arrangement	20-8*	20-9*	20-14	20-15	20-16	20-17
Service Rating	Inst.	H = D; Bal. = A	A	A	A	A
Number of Contacts	2 4	1 7	2 3	7	2 7	5 1
Contact Size	8 16	12 16	8 12	12	12 16	12 16

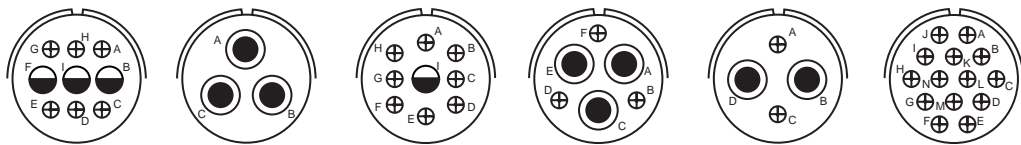

Insert Arrangement	20-18	20-19	20-21	20-22	20-24	20-27
Service Rating	A	A	A	A	A	A
Number of Contacts	3 6	3	1 8	3 3	2 2	14
Contact Size	12 16	8	12 16	8 16	8 16	16

* Consult Amphenol, Sidney, NY for availability.

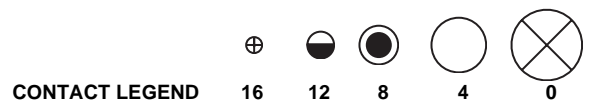

MS/Standard contact arrangements

front face of pin insert or rear face of socket insert illustrated

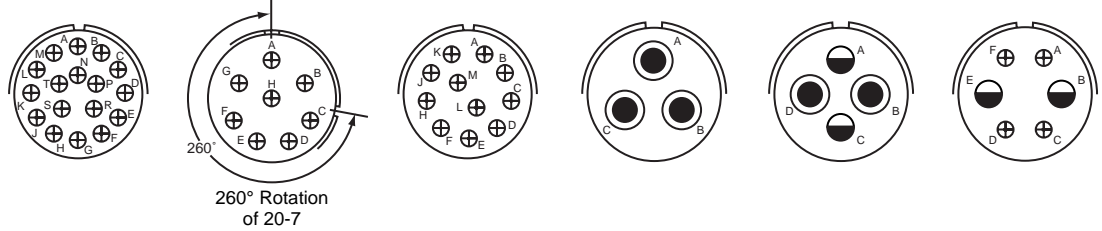

Insert Arrangement	20-29	20-32	20-33	22-2	22-4**	22-5
Service Rating	A	A, B, G, H = D; Bal. = A	A	D	A	D
Number of Contacts	17	8	11	3	2 2	2 4
Contact Size	16	16	16	8	8 12	12 16

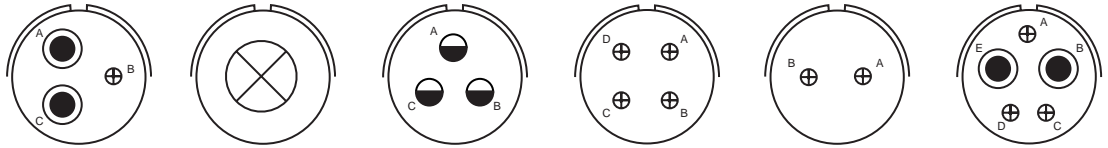

Insert Arrangement	22-6**	22-7*	22-9*	22-10*	22-11*	22-12*
Service Rating	D	E	E	E	B	D
Number of Contacts	2 1	1	3	4	2	2 3
Contact Size	8 16	0	12	16	16	8 16

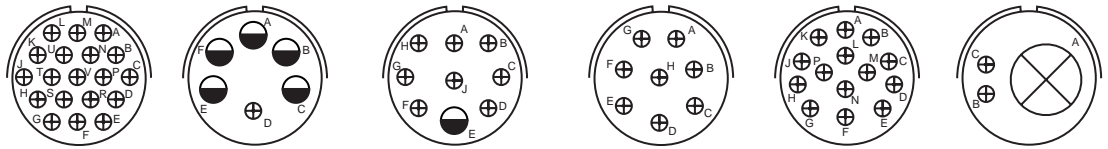

Insert Arrangement	22-14	22-15*	22-17*	22-18*	22-19	22-21
Service Rating	A	D = 3; Bal. = A	A = D; Bal. = A	C, D, E = A; Bal. = D	A	A
Number of Contacts	19	5 1	1 8	8	14	1 2
Contact Size	16	12 16	12 16	16	16	0 16

* Consult Amphenol, Sidney, NY for availability.
** Inactive for new design

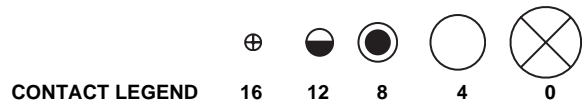

MS/Standard contact arrangements

front face of pin insert or rear face of socket insert illustrated

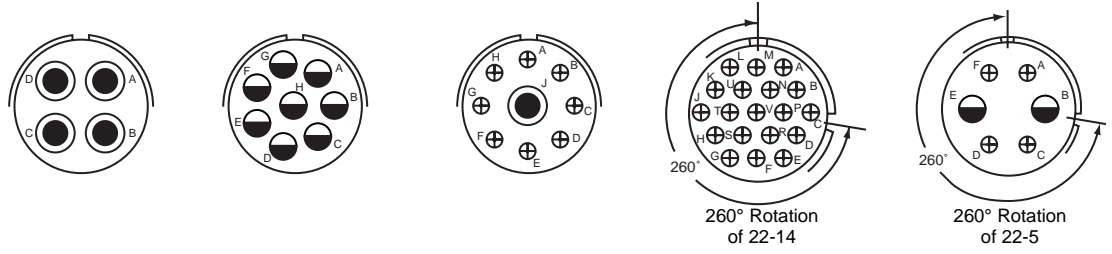

Insert Arrangement	22-22	22-23	22-27*	22-30	22-32
Service Rating	A	H = D; Bal. = A	J = D; Bal. = A	A	D
Number of Contacts	4	8	1 8	19	2 4
Contact Size	8	12	8 16	16	12 16

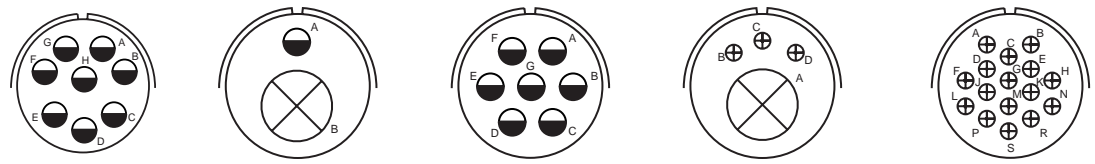

Insert Arrangement	22-36*	24-1**	24-2	24-4*	24-5**
Service Rating	H = D; Bal. = A	D	D	D	A
Number of Contacts	8	1 1	7	1 3	16
Contact Size	12	0 12	12	0 16	16

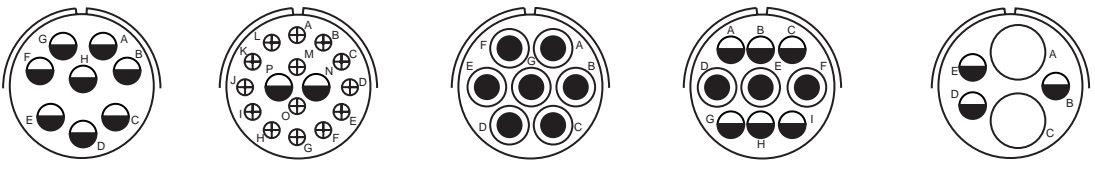

Insert Arrangement	24-6*	24-7	24-10	24-11	24-12
Service Rating	A, G, H = D; Bal. = A	A	A	A	A
Number of Contacts	8	2 14	7	3 6	2 3
Contact Size	12	12 16	8	8 12	4 12

* Consult Amphenol, Sidney, NY for availability.
 ** Inactive for new design

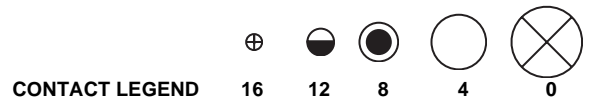

MS/Standard contact arrangements

front face of pin insert or rear face of socket insert illustrated

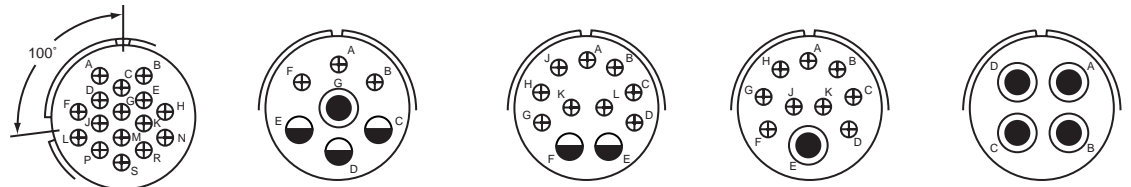

100° Rotation
of 24-5

Insert Arrangement	24-15	24-16*	24-20	24-21*	24-22
Service Rating	A	A, B, F, G = D; C, D, E = A	D	D	D
Number of Contacts	16	1 3 3	2 9	1 9	4
Contact Size	16	8 12 16	12 16	8 16	8

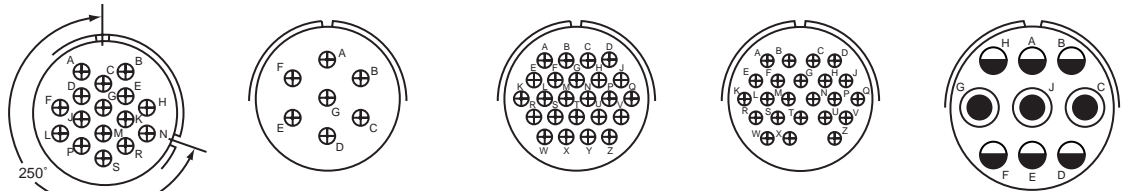

250° Rotation
of 24-5

Insert Arrangement	24-24	24-27*	24-28	24-80*	28-1
Service Rating	A	E	Inst.	Inst.	A, J, E = D; Bal. = A
Number of Contacts	16	7	24	23	3 6
Contact Size	16	16	16	16	8 12

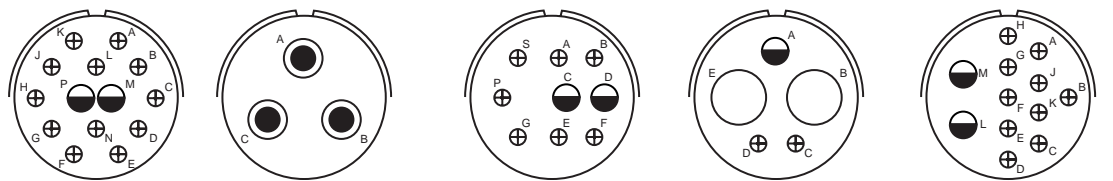

Insert Arrangement	28-2	28-3*	28-4*	28-5*	28-8*
Service Rating	D	E	G, P, S = E; Bal. = D	D	L, M = E; B = D; Bal. = A
Number of Contacts	2 12	3	2 7	2 1 2	2 10
Contact Size	12 16	8	12 16	4 12 16	12 16

* Consult Amphenol, Sidney, NY for availability.

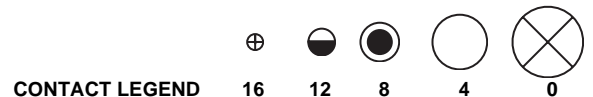

MS/Standard contact arrangements

front face of pin insert or rear face of socket insert illustrated

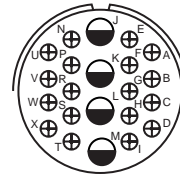
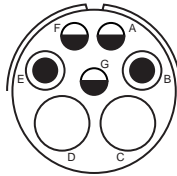
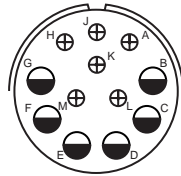

Insert Arrangement
Service Rating
Number of Contacts
Contact Size

28-9
D
6 6
12 16

28-10
G = D, Bal. = A
2 2 3
4 8 12

28-11
A
4 18
12 16

28-12
A
26
16

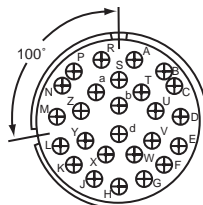

100° Rotation
of 28-12

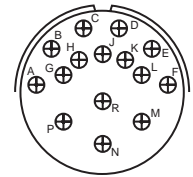
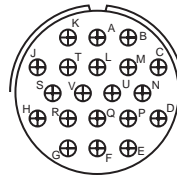
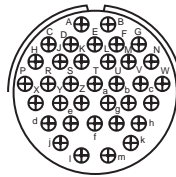

Insert Arrangement
Service Rating
Number of Contacts
Contact Size

28-13
A
26
16

28-15
A
35
16

28-16**
A
20
16

28-17
R = B; M, N, P = D; Bal. = A
15
16

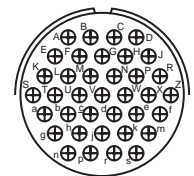
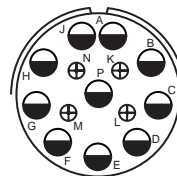
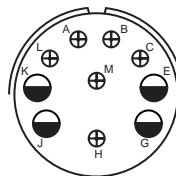
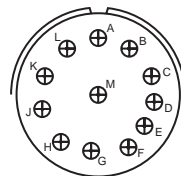

Insert Arrangement
Service Rating
Number of Contacts
Contact Size

28-18*
M = C; G, H, J, K, L = D; A, B = A; Bal. = Inst.
12
16

28-19*
H, M = B; A, B = D; Bal. = A
4 6
12 16

28-20
A
10 4
12 16

28-21
A
37
16

* Consult Amphenol, Sidney, NY for availability.
** Inactive for new design



MS/Standard contact arrangements

front face of pin insert or rear face of socket insert illustrated

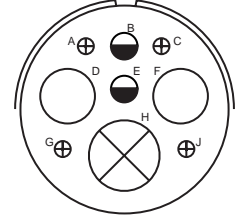
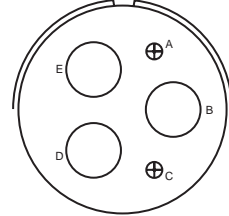
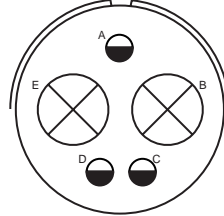
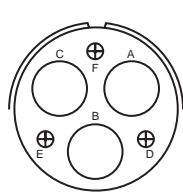

Insert Arrangement	28-22	32-1	32-2*	32-3*
Service Rating	D	A = E; B, C, D, E = D	E	D
Number of Contacts	3 3	2 3	3 2	1 2 2 4
Contact Size	4 16	0 12	4 16	0 4 12 16

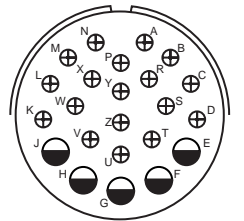
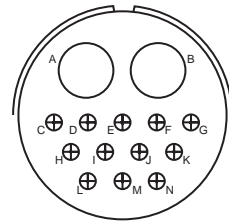
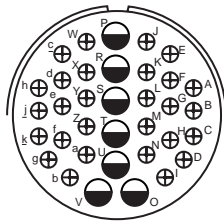
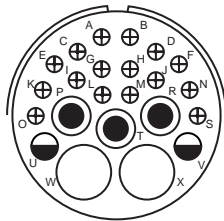

Insert Arrangement	32-6	32-7	32-9	32-13
Service Rating	A	A, B, h, j = Inst.; Bal. = A	D	D
Number of Contacts	2 3 2 16	7 28	2 12	5 18
Contact Size	4 8 12 16	12 16	4 16	12 16

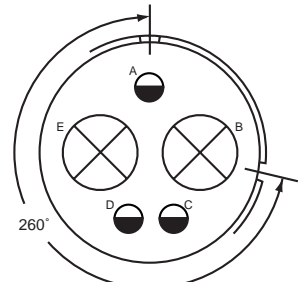
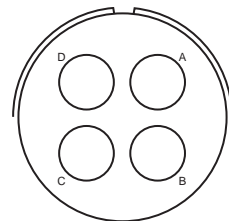
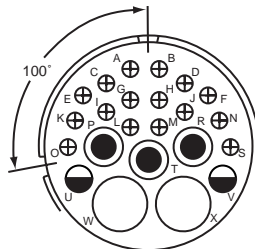
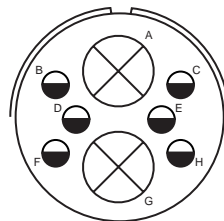

Insert Arrangement	32-15	32-16	32-17	32-19*
Service Rating	D	A	D	A = E, Bal. = D
Number of Contacts	2 6	2 3 2 16	4	2 3
Contact Size	0 12	4 8 12 16	4	0 12

* Consult Amphenol, Sidney, NY for availability.

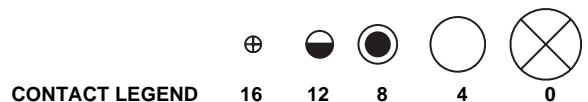

MS/Standard contact arrangements

front face of pin insert or rear face of socket insert illustrated

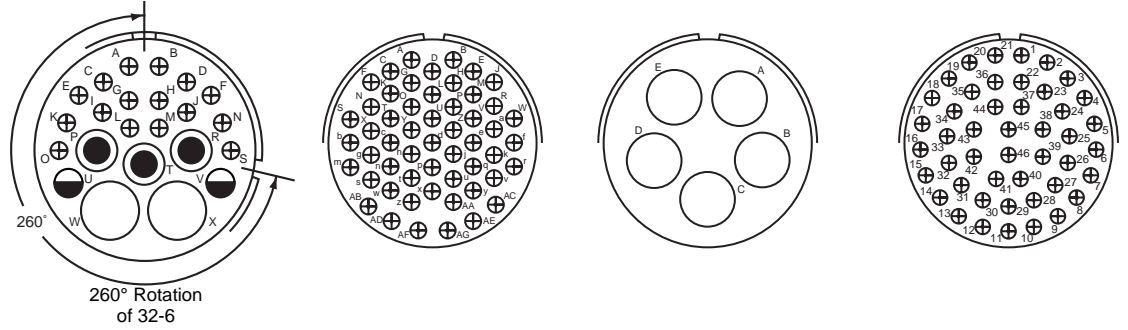

Insert Arrangement	32-20	32-22*	32-63	32-73
Service Rating	A	A	D	A
Number of Contacts	2 3 2 16	54	5	46
Contact Size	4 8 12 16	16	4	16

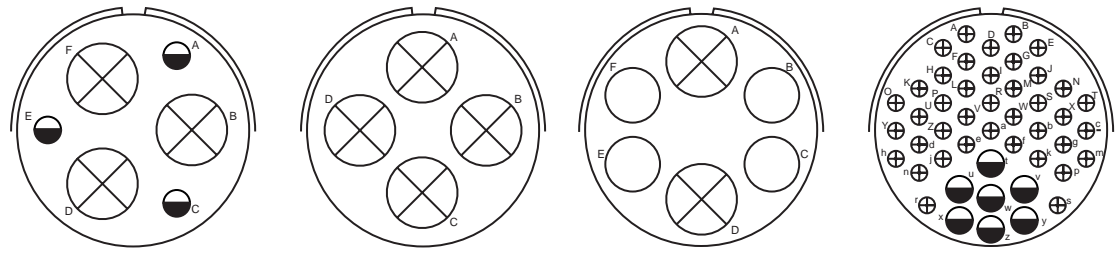

Insert Arrangement	36-3	36-5	36-6	36-7
Service Rating	D	A	A	A
Number of Contacts	3 3	4	2 4	7 40
Contact Size	0 12	0	0 4	12 16

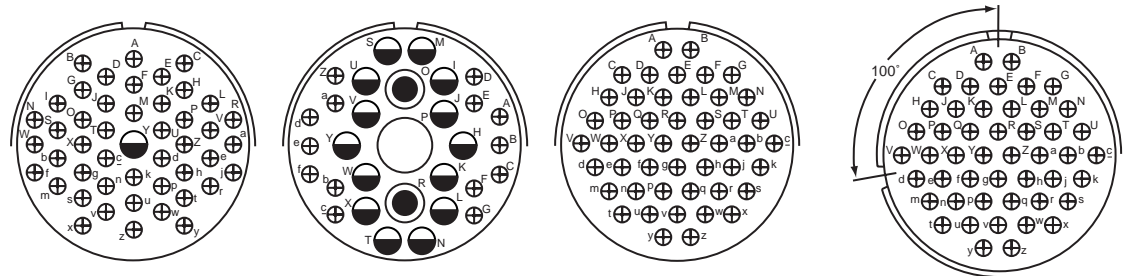

Insert Arrangement	36-8	36-9	36-10	36-11
Service Rating	A	A	A	A
Number of Contacts	1 46	1 2 14 14	48	48
Contact Size	12 16	4 8 12 16	16	16

* Consult Amphenol, Sidney, NY for availability.

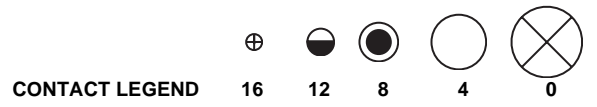

MS/Standard contact arrangements

front face of pin insert or rear face of socket insert illustrated

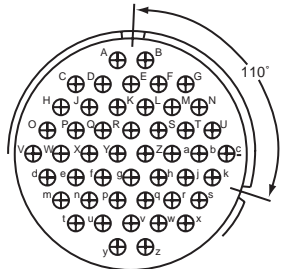

110° Rotation of 36-10

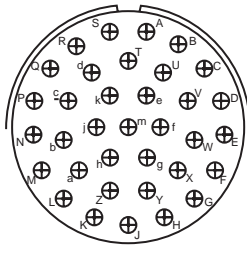

36-15
M = D, Bal. = A

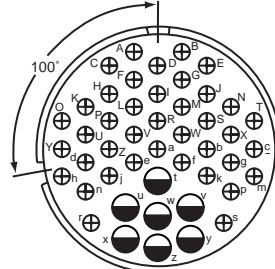

100° Rotation of 36-7

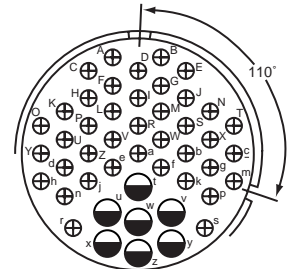

110° Rotation of 36-7

Insert Arrangement
Service Rating
Number of Contacts
Contact Size

36-12
A
48
16

36-15
M = D, Bal. = A
35
16

36-16
A
7 40
12 16

36-17
A
7 40
12 16

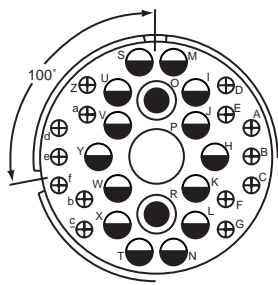

100° Rotation of 36-9

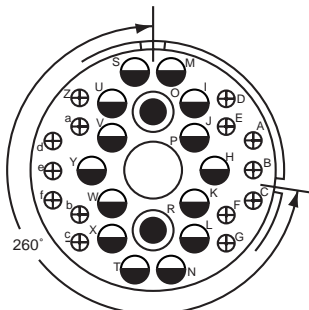

260° Rotation of 36-9

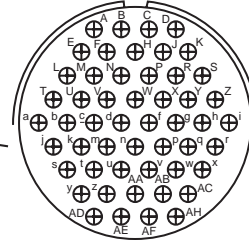

36-52
A
52
16

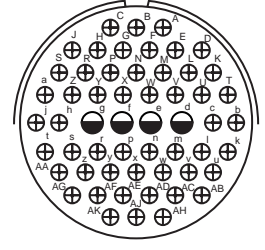

36-66*
A
4 52
12 16

Insert Arrangement
Service Rating
Number of Contacts
Contact Size

36-18
A
1 2 14 14
4 8 12 16

36-21
A
1 2 14 14
4 8 12 16

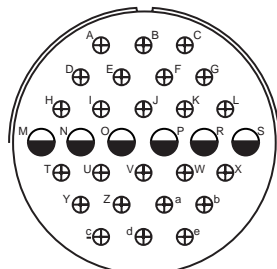

40-1
D
6 24
12 16

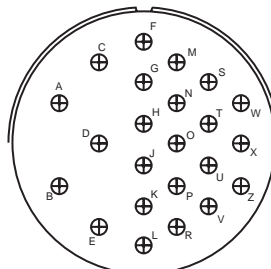

40-2*
D
23
16

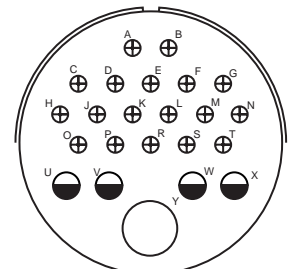

40-3*
D
1 4 18
4 12 16

Insert Arrangement
Service Rating
Number of Contacts
Contact Size

* Consult Amphenol, Sidney, NY for availability.

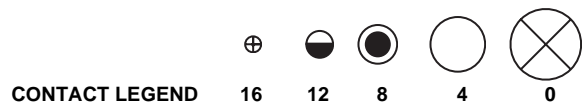

MS/Standard contact arrangements

front face of pin insert or rear face of socket insert illustrated

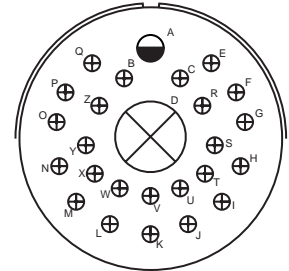
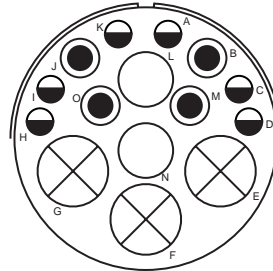
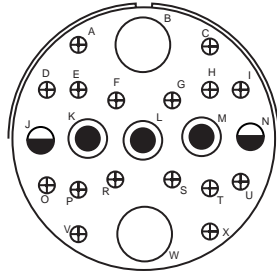

Insert Arrangement
Service Rating
Number of Contacts
Contact Size

40-4*
D
2 3 2 16
4 8 12 16

40-5*
A
3 2 4 6
0 4 8 12

40-6*
D
1 1 24
0 12 16

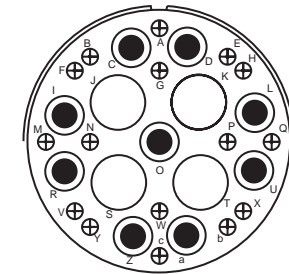
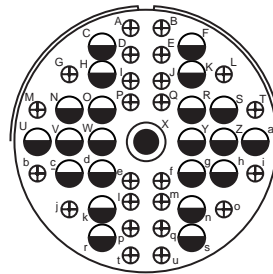
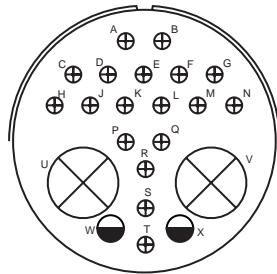

Insert Arrangement
Service Rating
Number of Contacts
Contact Size

40-7*
P, Q, U, V, W, X = A; Bal. = D
2 2 18
0 12 16

40-9
A
1 22 24
8 12 16

40-10*
A
4 9 16
4 8 16

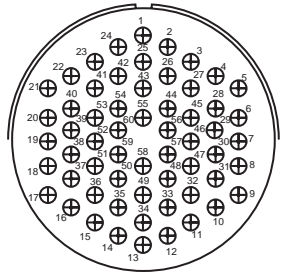
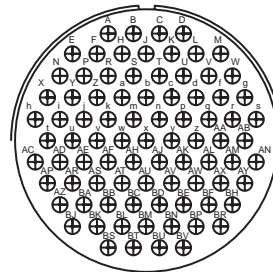
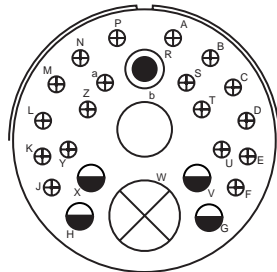

Insert Arrangement
Service Rating
Number of Contacts
Contact Size

40-11*
D
1 1 1 4 18
0 4 8 12 16

40-56*
A
85
16

40-62*
A
60
16

* Consult Amphenol, Sidney, NY for availability.

