

## Features

- 12 strain gage inputs
- 24-bit/delta-sigma ADC per channel
- 50-kHz per channel sample rate
- User programmable excitation
- Simultaneous sampling
- Remote sensing
- Shunt calibration
- Eight digital I/O
- Multiple trigger modes
- Compact, portable design
- Expandable using multiple 6000 Series modules

## Software

- Includes Encore interactive measurement software for *Out-of-the-Box* setup, acquisition, display, logging, analysis, and reporting
- Advanced feature set with no programming required
- True drag-and-drop functionality
- Easy-to-use set-up wizards
- Drag data directly to Excel®
- Included data analysis tools
- Playback mode
- Sophisticated test report capability
- Incorporate multiple 6000 Series devices into one application
- Supported Operating Systems: Windows 2000®, Windows Vista® x86 (32-bit), and Windows XP® (32-bit)

## Overview

The 6000 Series combines accurate, instrument class, Ethernet-based modules with powerful, easy-to-use software. It is a major advancement in ease of use and functionality. 6000 Series modules feature integrated signal conditioning and a modular design that allows for system expansion. Because they use an Ethernet connection, modules can be connected directly to a PC or used in remote configurations utilizing multiple modules. Modules are offered for voltage or direct strain inputs.

Each 6000 Series module includes Encore interactive measurement software. Encore couples ease-of-use with advanced functionality including custom data displays, powerful analysis, and detailed reporting capabilities.



The 6224 with Encore software is a portable, strain gage measurement solution

6000 Series Modules		
Feature	6220	6224
Analog inputs	12	12
Digital I/O	8	8
Resolution	16-bit	24-bit
Sample rate	100-kHz per channel	50-kHz per channel
Analog input type	voltage	strain gage/bridge

## Direct Strain Gage Inputs

The 6224 is equipped with 12 analog input channels capable of measuring full-, half-, or quarter-bridge sensors. Each of the 12 analog channels has its own 24-bit ADC and input amplifier allowing all 12 channels to be sampled simultaneously. The 6224 also includes anti-aliasing filters. All strain input signals are attached via 12 RJ45 connectors mounted on the front of the module.

The 6224 features direct strain gage inputs. Half or full-bridge sensors are supported. Quarter-bridge sensors are also supported using an external resistor. The 6224 is also 100% software programmable. Excitation, auto-zero, and shunt calibration are each adjusted in software without relying on manually adjusted trimpots which can cause increased error and drift. Excitation is provided by the 6224 and can be software selected for 2.5V, 3.3V, 5V,

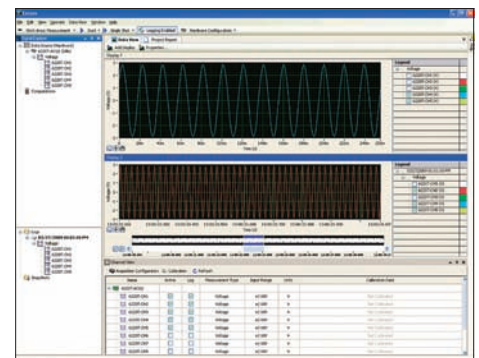

Encore provides real-time viewing and analysis of data along with built-in test report capabilities

or 10V. For excitation values beyond those listed, an external excitation source may be used. Connectors are provided on the front of the unit for excitation source wiring.

# 6224

## General Information

6224 Block Diagram

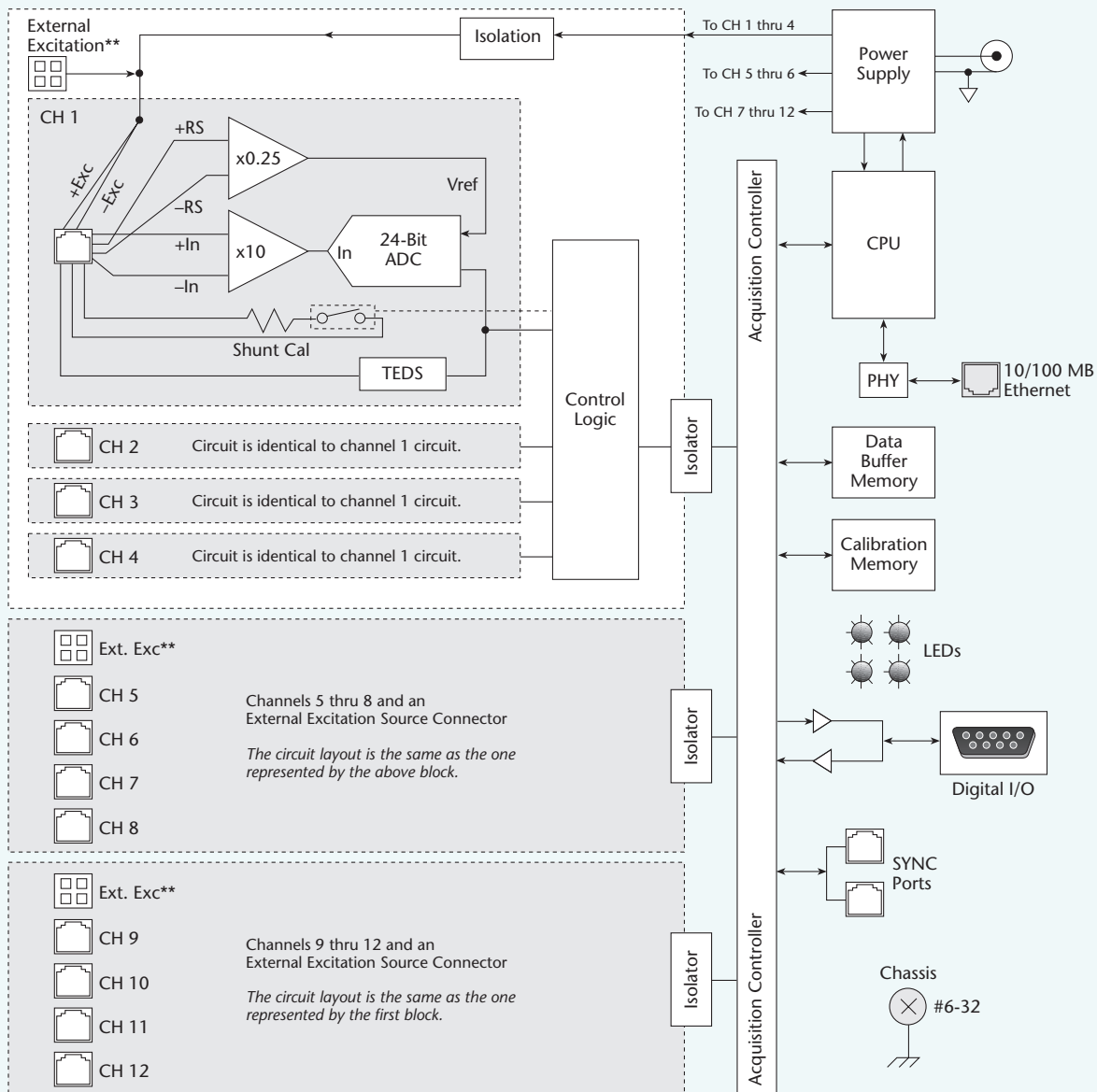

\*\* There are three External Excitation Voltage Source Connectors.  
The first serves channels 1 thru 4.  
The second serves channels 5 thru 8.  
The third serves channels 9 thru 12.

### Shunt Calibration

Shunt calibration enables each channel to be put into a known imbalance condition to set or verify channel calibration. Shunt-cal allows a full scale gain to be set without physically loading the bridge to capacity.

### Remote Sensing

Remote sensing automatically and continuously corrects for voltage drop errors in excitation leads.

# 6224

## General Information

### 6224 System Examples

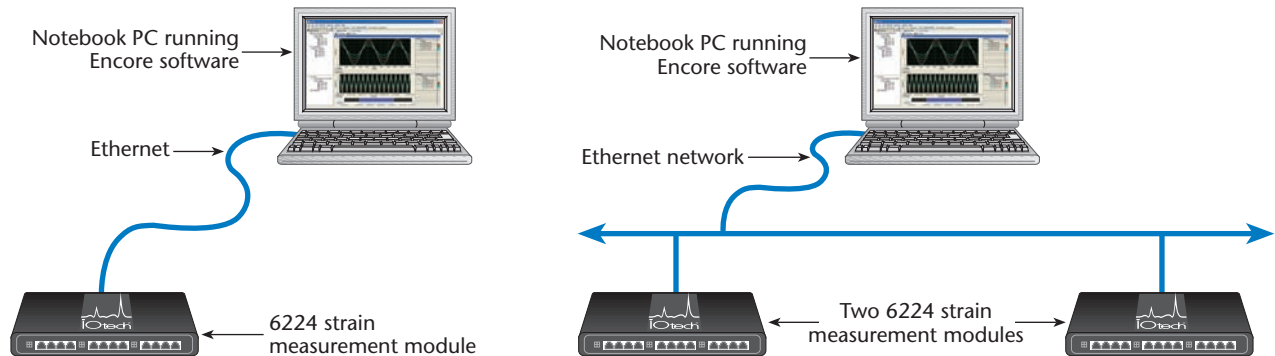

*The CN-268 is an RJ50 to 12-pin screw terminal break-out connector module. The CN-269 and CN-270 offer internal bridge completion resistors for quarter-bridge configurations.*

### Signal Connections

The 12 strain gage inputs on the 6224 are accessed via 12 RJ50 front panel connectors. 12 user specified connector modules are included with the 6224.

#### Full- and Half-Bridge Configurations

The 6224 supports full- and half-bridge configurations directly. Users can connect to the RJ50 front panel connectors or use the CN-268 12-pin screw terminal break-out connector module.

#### Quarter-Bridge Configurations

For quarter-bridge configurations the CN-269 and CN-270 feature 120 Ohm and 350 Ohm internal bridge completion resistors respectively. The CN-269 and CN-270 feature an RJ50 female connector one end and screw terminals on the other. One module is required for each channel.

### Digital I/O

The 6224 includes eight digital I/O lines. All eight lines are accessible via a 9-pin female DSUB connector located on the rear panel of the unit. Each digital I/O bit can be programmed individually to be either an input or an output.

### Triggering

A variety of trigger modes are supported by the 6224. A wide selection of programmable analog and digital trigger modes are available for starting an acquisition. All trigger modes, along with the number of scans and the sample rate for pre- and post-trigger data, are software programmable prior to the start of a scan sequence.

### System Power Connection

The 6224 and other 6000 Series modules offer the flexibility to be powered either directly from a 19V to 30V DC source, or via the included TR-60U AC power adapter.

### Ethernet Features

The 6000 Series transfers acquired data to the PC via 10/100BaseT Ethernet, allowing a continuous stream of data to be collected and stored in a PC's memory or hard drive. The most common and highest-performance connection is with dedicated, point-to-point Ethernet link between the PC and the 6224. With an enterprise-wide Ethernet network connection, any number of 6000 Series modules can be connected to the network.

# 6224

## Specifications

### Specifications

The following specifications are typical for the temperature range -40 to 50°C unless otherwise noted.

#### Input Characteristics

Number of Analog Channels: 12

Bridge Completion

Full and Half: Internal

Quarter: External

ADC Resolution: 24 bits

Type of ADC: Delta-sigma (with analog pre-filtering)

Sampling Mode: Simultaneous

Data Rates (fs): (50 kS/s)/n, n = 1, 2, ... 31.

Master Timebase (Internal)

Frequency: 12.8 MHz

Accuracy: ±100 ppm max

Nominal Full-Scale Range: ±25 mV/V

Scaling Coefficient: 2.9802 nV/V per LSB

Overvoltage Protection Between any Two Terminals: ±30V

#### Accuracy

Error*	Percent of Reading	Offset
Calibrated max (-40° to 50°C)	0.20%	0.0625 mV/V
Calibrated typ (25°C, ±15°C)	0.05%	0.0125 mV/V

\* Excluding offset null or shunt calibration.

Gain Drift: 10 ppm/°C max

Offset Drift

2.5V Excitation: 0.6 µV/V per °C

3.3V Excitation: 0.5 µV/V per °C

5V Excitation: 0.3 µV/V per °C

10V Excitation: 0.2 µV/V per °C

#### Channel-to-Channel Matching (Calibrated)

Input Signal Frequency ( $f_{in}$ )	Gain		Phase
	Typical	Maximum	Maximum
0 to 1 kHz	0.15%	0.3%	$0.125^\circ/\text{kHz} \cdot f_{in}^\dagger$
1 to 20 kHz	0.4%	1.1%	$0.125^\circ/\text{kHz} \cdot f_{in}^\dagger$

†  $f_{in}$  is in kHz

Phase Nonlinearity

0 to 1 kHz: <0.001°

0 to 20 kHz: ±0.1°

Input Delay: 4.8 µs + 38.4/fs

Passband

Frequency: 0.45 · fs

Flatness: 0.1 dB max

Stopband

Frequency: 0.55 · fs

Attenuation: 100 dB

Alias-Free Bandwidth: 0.45 · fs

Oversample Rate: 64 · fs

Attenuation at Oversample Rate<sup>1</sup>

50 kS/s: 90 dB @ 3.2 MHz

10 kS/s: 60 dB @ 640 kHz

Common-Mode Voltage

All Signals to Earth Ground: ±60 VDC

Common-Mode Rejection Ratio (CMRR)

Relative to Earth Ground<sup>2</sup>: -140 dB @ 0 to 60 Hz

Relative to EX-: -85 dB @ 0 to 1 kHz

<sup>1</sup> Rejection by analog prefilter of signal frequencies at oversample rate.

<sup>2</sup> Measured with a balanced cable. Shielded cables may be significantly unbalanced.

#### Input Noise

Excitation Voltage	Density (nV/V <sub>rms</sub> per √1 Hz)	Total (50 kS/s) (µV/V <sub>rms</sub> )	0 to 1 kHz (nV/V <sub>rms</sub> )
2.5V	8	1.3	250
3.3V	6	1.0	190
5.0V	4	0.6	130
10.0V	2	0.3	65

Spurious-Free Dynamic Range (SFDR): 106 dB, (1KHz, -60 dBFS)

Total Harmonic Distortion (Fundamental @ -20 dBFS)

1 kHz: -100 dB

8 kHz: -90 dB

Excitation Noise: 0.1 mV/V<sub>rms</sub>

Crosstalk

1 kHz: -110 dB

10 kHz: -100 dB

Shunt Calibration

Resistance: 100k Ohm

Resistor Accuracy

25°C: ±110 Ohm

-40° to 70°C: ±200 Ohm

Excitation

Internal Voltage: 2.5V, 3.3V, 5.0V, 10.0V

Internal Power: 450 mW max

External Voltage: 2V to 10V

#### Digital I/O

Channels: 8 digital I/O, programmable as single port, or as individual lines

Power-Up Mode: Inputs pulled low

Connector: DB-9 female

Input Scanning Modes

Asynchronous: Under program control at any time relative to analog scanning

Synchronous: Data captured synchronously with the analog channels

Input Levels

Low: 0 to +0.8V

High: +2.0V to +5.0V

Input Voltage Range without Damage: -0.6V to +5.6V max

Input Pull-Down Resistor: 10k Ohm

Output Voltage Range: 0 to +3V, (may be externally pulled up to 5.6V without damage)

Output Resistance: 40 Ohm

Sampling: 1 MHz max continuous

Output Timing: Outputs are always written asynchronously

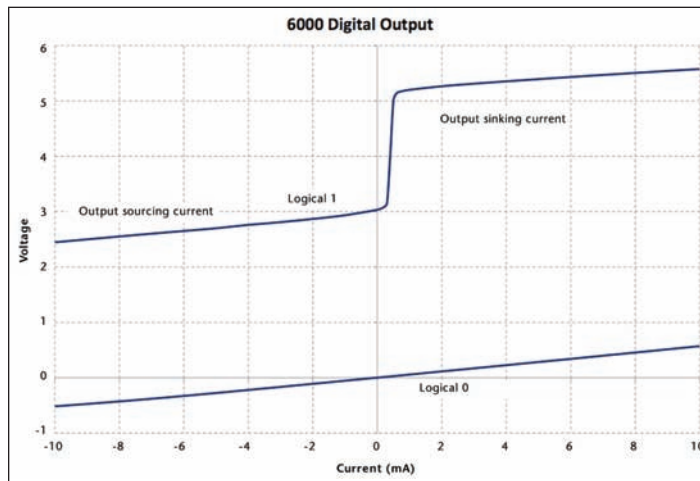

# 6224

## Specifications and Ordering Information

### Power Consumption

6.3W typ, 6.6W max  
24 VDC @ 0.8A max

### Physical Characteristics

**Weight:** 1.3 kg (2.88 lbs)  
**Dimensions:** 276.9 mm W x 169.8 mm D x 30.5 mm H (10.9" x 6.685" x 1.2")

### Environmental

The IOtech 6224 is intended for indoor use only but may be used outdoors if installed in a suitable enclosure.

**Operating Temperature (IEC 60068-2-1, IEC 60068-2-2):** -40 to 50°C

**Storage Temperature (IEC 60068-2-1, IEC 60068-2-2):** -40 to 75°C

**Ingress Protection:** IP 40

**Operating Humidity (IEC 60068-2-56):** 10 to 90% RH, noncondensing

**Storage Humidity (IEC 60068-2-56):** 5 to 95% RH, noncondensing

**Maximum Altitude:** 2,000 m (6,562 ft.)

**Pollution Degree (IEC 60664):** 2

### Calibration

**Calibration Interval:** 1 year; contact IOtech for information regarding calibration service.

## Ordering Information

Description	Part No.
12-channel, 24-bit resolution, Ethernet-based strain measurement module, with included <i>Out-of-the-Box</i> Encore software	6224

### Accessories & Cables

External power supply, 90 to 264 VAC; requires additional cable, CA-1 (US) or CA-216 (European)	TR-60U CA-1
Required cable for use with TR-60U; 120V US version	CA-216
Required cable for use with TR-60U; 220V European version	CA-74-1
RJ12 shielded cable, 6 conductor, SYNC, 0.3m (1 ft.) <sup>1</sup>	CN-268
RJ50, 12-pin screw-terminal connector, 4 pack	CN-269
RJ50, 120 Ohm quarter bridge connector, 4 pack	CN-270
RJ50, 350 Ohm quarter bridge connector, 4 pack	CA-272-01
RJ50 to RJ50 M/M, 1 meter cable, 4 pack	CA-192-7C
Ethernet crossover cables, 2.133m (7 ft.)	CA-242
Ethernet patch cable, 0.457m (1.5 ft.) <sup>2</sup>	CA-242-7
Ethernet patch cable, 2.133m (7 ft.) <sup>2</sup>	190658A-01
Stacking plate kit	HA-210-5-BK
Handle kit	

## BUY NOW!

For complete product specifications, pricing, and accessory information, call 1-888-714-3272 (U.S. only) or visit [iotech.com/6000series](http://iotech.com/6000series).

- <sup>1</sup> Up to nine units can be synchronized. The total combined length of the SYNC cables is not to exceed 2.438m (8 ft.).
- <sup>2</sup> Ethernet cable length must be <10m (32.8 ft.) in order for the system to be CE Compliant.
- <sup>3</sup> Ethernet crossover cables should only be used for direct network connections. In particular, attempting to connect a device to a Hub using a crossover cable may prevent that network link from functioning. Some modern routers have become an exception by including logic to detect the crossover cable and allow the network link to function.

## Features

- Interactive measurement software for *Out-of-the-Box* setup, acquisition, display, logging, analysis, and reporting
- Included with 6000 Series Ethernet-based data acquisition modules
- Advanced feature set with no programming required
- Drag-and-drop functionality
- Easy-to-use set-up wizards
- Ability to drag data directly to Excel®
- Included data analysis tools
- Playback mode
- Sophisticated test report capability
- Incorporate multiple 6000 Series devices into one application
- Supported Operating Systems: Windows 2000®, Windows Vista® x86 (32-bit), and Windows XP® (32-bit)

## Overview

Encore is the premier *Out-of-the-Box* data acquisition software package and is included with each 6000 Series module. Encore combines ease of use with advanced functionality, including customizable data layouts, powerful analysis, and reporting capabilities. Instead of having a program to log data, another to analyze, and a third to develop report data, Encore includes the functionality of all three into one package, thus shortening the learning curve, and saving time and cost.

## Configuration

Easy-to-use set-up wizards provide rapid hardware configuration. Encore allows you to go from setup to taking measurements in minutes. Users can select one or more available devices from Encore's Hardware Configuration dialog.

Encore allows you to configure the basic acquisition or generation options, such as channel selection, acquisition rate, number of points, and input range. You can also configure start and stop triggers.

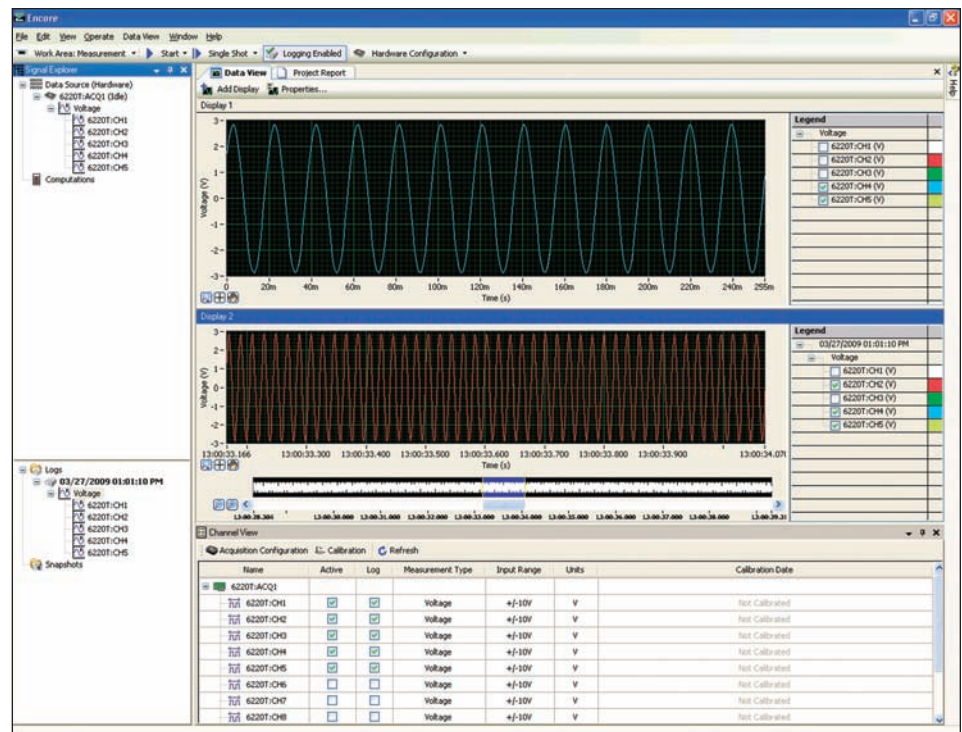

Encore offers an intuitive user interface. Data displays can be configured with multiple charts, overlapping data plots, and user selectable scales.

In addition, within the Channel View table, users can enable (or disable) channels, select measurement type, enable logging, perform mx+b calculation, and more. Channel View configurations can also be shared among multiple projects.

## Measurement

Encore allows you to develop data displays quickly with an intuitive, drag-and-drop interface. Encore also offers the ability to easily change plot colors, overlay channels (including previously recorded data), and access multiple devices. Additionally, you can export data to other formats including Excel, ASCII and DIAdem.

## Triggering

A variety of programmable analog and digital trigger conditions are available for starting and stopping an acquisition within Encore. Analog triggers include Rising Edge, Falling Edge (with hysteresis), Above Level, Below Level, Inside Window, and Outside Window. Digital triggers include Rising Edge, Falling Edge, Level High, or Level Low. In addition, the Duration trigger may be used to stop an acquisition after a specified time.

## Analysis

Included analysis options make Encore IOtech's most advanced *Out-of-the-Box* software package. Features include FFT, power spectrum, statistics, peak value, and RMS calculation. In addition, you can also create custom formulas using Encore's Create Calculated Signal function. Data can also be viewed in the playback work area. Analysis can be computed on live data as well as logged data (post processing).

Analysis options include:

- Statistics: Standard Deviation, Mean, and Variance
- Peak: +Peak, -Peak, and Peak-Peak
- RMS
- DC
- FFT
- Power Spectrum
- Minimum
- Maximum

## Export to Excel®

Signals can be exported from Encore to Microsoft Excel. When exporting signals from Encore to Microsoft Excel, the following information is exported:

- Signal name
- Export date and time
- Signal units
- Data values

## Reporting

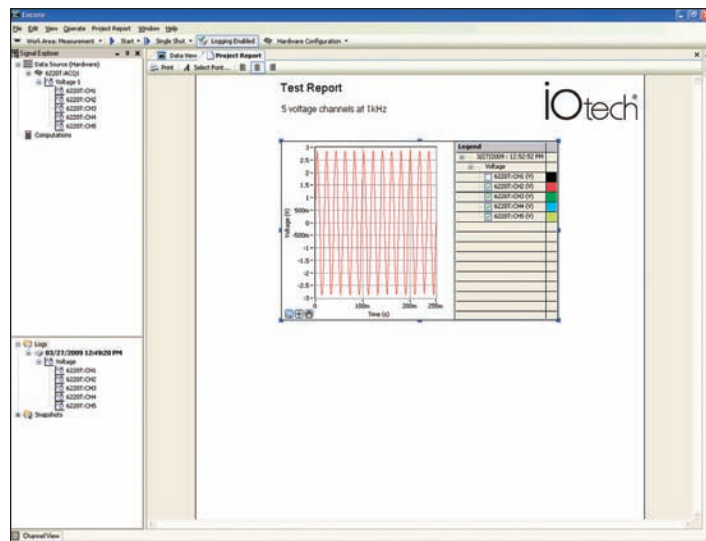

*In the Project Report tab you can drag signals from the Signal Explorer, enter text, change fonts, import images, and print or export reports to html*

Encore offers sophisticated, built-in test reporting capability which provides the ability to present data in a professional manner. With Encore's test report capability, users can easily develop in-depth test reports.

Within Encore's Project Report tab users can drag signals from the application directly into the report and then enter text, change fonts, import images and print or export reports. Once the report is complete, you even have the ability to acquire new data and easily update any previous report, without re-creating the report. The report can be edited throughout the life of the project.

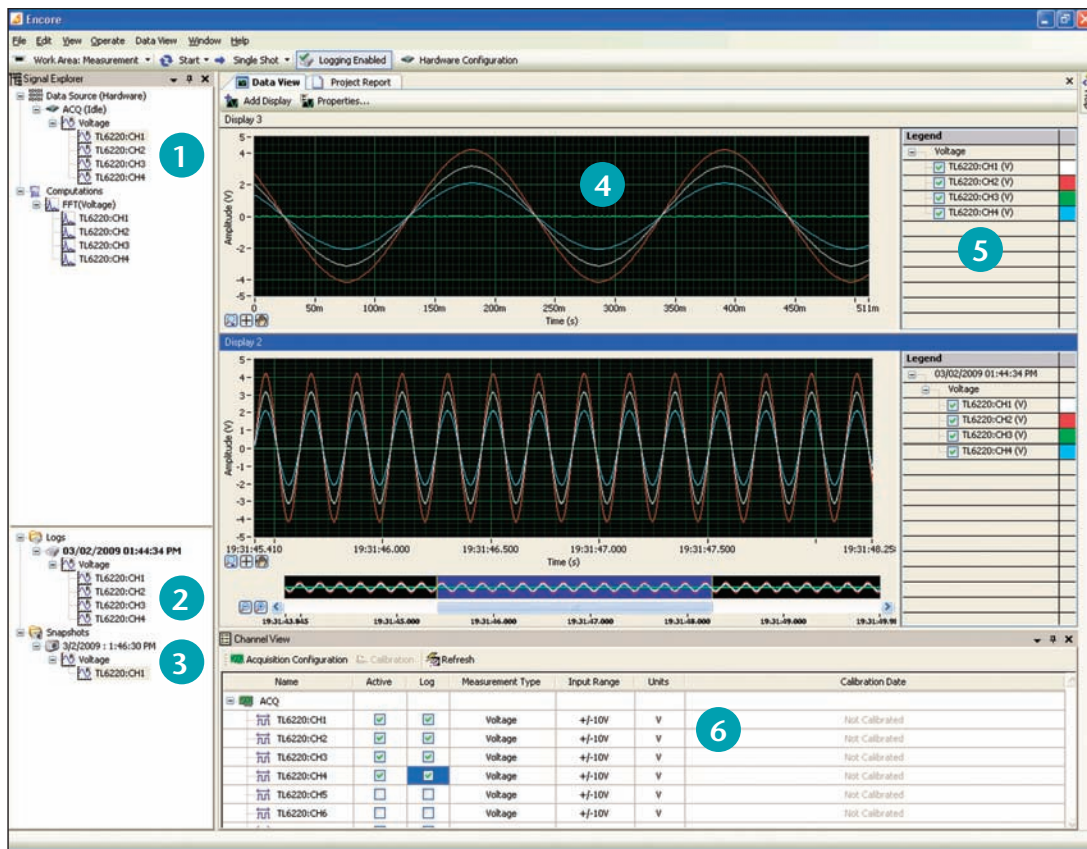

- 1 Signal Explorer** displays the data sources, computations, snapshots and logs available for your project. It also allows you to select and drag signals into the Data View. Signals can also be dragged directly Into Excel.
- 2 Log Window** displays a list of a project's logged data [including snapshots] sorted by the time at which you recorded the log or took the snapshot.
- 3 Snapshots** allow you to save a record of the current values of any signal in your project. You can use snapshots as a reference signal to compare data within the same or another project.
- 4 Data View** tab allows you to view your data by dragging signals directly from the Signal Explorer or the Log Window. The Data View tab can display signals in several formats, including graphs, charts, and various numeric representations. When you drag a signal to the Data View tab, the signal appears in a new or existing display depending on whether a display showing that type of data already exists.
- 5 Legend (Graph Legend)** lists every signal displayed in the graph and also shows its corresponding plot color.
- 6 Channel View** is a table-style section which gives you an overview of all your channels and their settings. You can enable (or disable) channels, select the measurement type, enable (or disable) logging, perform mx+b calculation, and more. You can also use the Channel View toolbar to quickly jump to Acquisition Configuration or [system] Calibration windows.