

Personal Daq/50 Series

USB Data Acquisition Modules

Models /54, /55, & /56

iOtech[®]
iotech.com

Features

- Multifunction data acquisition modules attach to PCs via Universal Serial Bus (USB 1.1 & 2.0 compatible)
- Ultra low-power design requires no external power or batteries
- Can be located up to 5 meters (16.4 feet) from the PC
- High-resolution, 22-bit A/D converter offers reading rates from 1 to 80 Hz
- Built-in cold-junction compensation for direct thermocouple measurements
- Frequency/pulse, or duty-cycle measurements up to 1 MHz*
- Convenient removable screw-terminal signal connections
- 500V optical isolation from PC for safe and noise-free measurements
- Programmable inputs from ± 31 mV to ± 20 V full scale
- Digital I/O lines with open collector output for direct drive applications*
- Expandable up to 80 channels of analog and digital I/O*
- Up to 100 Personal Daq modules can be attached to one PC using USB hubs, for a total capacity of 8,000 channels
- Digital calibration—no potentiometers or adjustments required

Software

- Personal DaqView *Out-of-the-Box* spreadsheet-style software for setup, acquisition, and real-time display
- PostView included for post-acquisition data viewing
- Support for Visual Basic[®], C/C++, DASyLab[®], and LabVIEW[®]
- Supported Operating Systems: Windows 2000[®], Windows Vista[®] x86 (32-bit), and Windows XP[®]

Designed for high accuracy and resolution, the 22-bit Personal Daq data acquisition systems directly measure multiple channels of voltage, thermocouples, pulse, frequency, and digital I/O*. A single cable to the PC provides high-speed communication *and* power to the Personal Daq. No additional batteries or power supplies are required in most applications**.

The Personal Daq modules are a family of low-cost, USB-based products from IOtech. Because of the strict power limitations of the USB, the modules incorporate special



power-management circuitry to ensure adherence to USB specifications.

The Personal Daqs avoid many of the limitations of PC-Card (PCMCIA) data acquisition devices. The Personal Daq/54 data acquisition system offers 10 single-ended or 5 differential analog (up to ± 20 V full scale), or thermocouple input channels. The Personal Daq/55 offers 10 single-ended, or 5 differential analog (up to ± 20 V full scale) or thermocouple input channels, 16 programmable ranges, 500V optical isolation, eight digital I/O lines, and two frequency/pulse/duty-cycle channels. The Personal Daq/56 offers twice the I/O capacity of the Personal Daq/55, in the same size package.

To simplify attachment of signals and transducers, the Personal Daq modules feature convenient, removable screw-terminal input connections.



The compact Personal Daq is ideal for portable data acquisition applications

* The Personal Daq/54 does not have frequency, digital I/O, or expansion capability

** In rare instances an external power source is required when PC-supplied power is inadequate

Personal Daq/50 Series

General Information



Personal Daq with removable terminal block

Software

The Personal Daqs are supplied with Personal DaqView, IOtech's Windows®-based data logging application that allows you to set up your acquisition applications and save acquired data directly to disk. The Personal Daqs are also shipped with PostView, a post-acquisition application that permits you to display acquired data previously saved to a file. Drivers for Visual Basic® and C/C++ for Windows® 2000/XP/Vista (32-bit) are also included. In addition, drivers are available for icon-based software packages, such as DASyLab® and LabVIEW®.

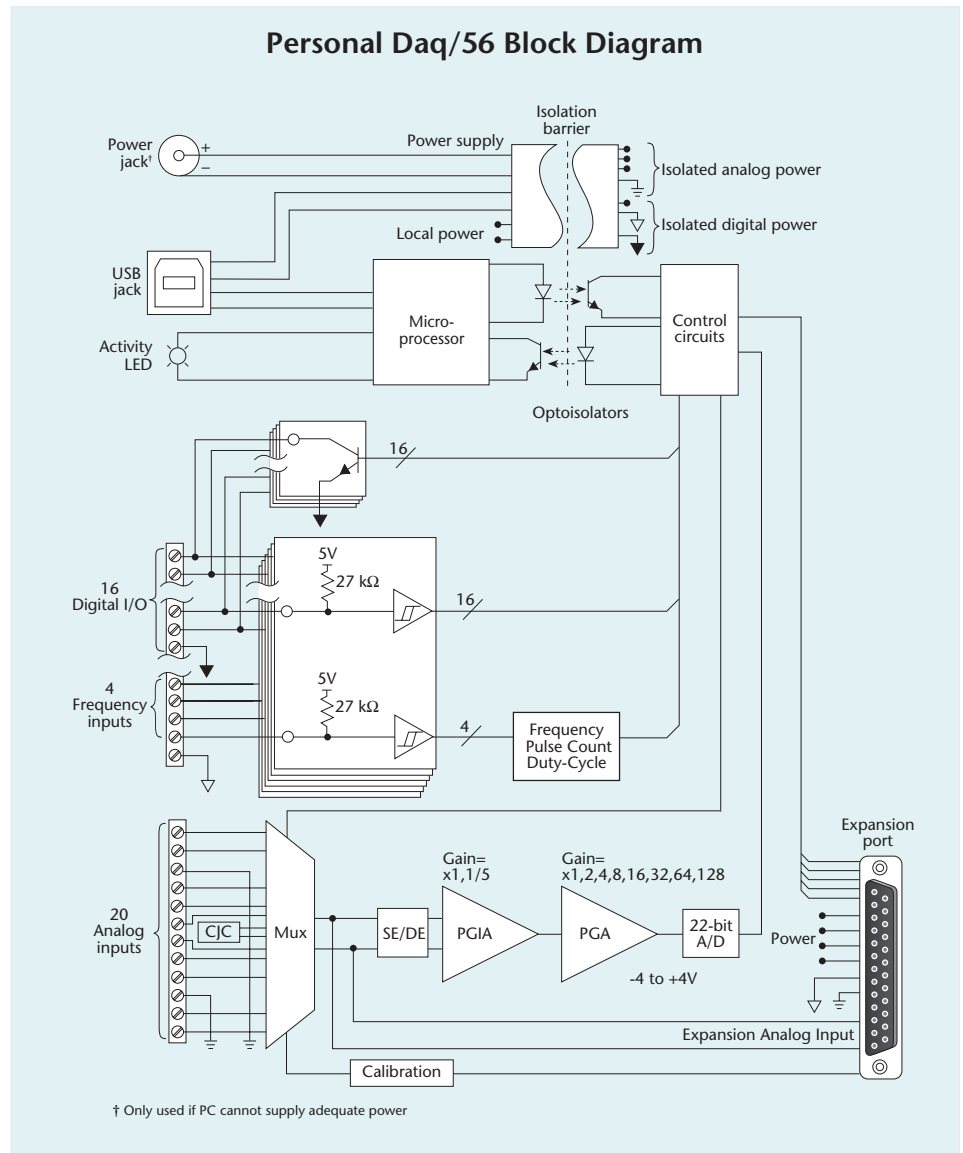

Personal Daq/50 Series

Expansion

Personal Daq Expansion

Both the Personal Daq/55 and the Personal Daq/56 can be easily expanded with one of two available snap-on expansion modules, bringing the total capacity up to 60 analog or thermocouple channels, 32 digital I/O lines, and 4 frequency input channels. Furthermore, USB hubs can be used to create multi-unit systems containing up to 100 Personal Daq modules attached to a single PC. Using this strategy, a multi-unit Personal Daq system can provide up to 8,192 analog and digital I/O lines.

See the chart to the right for available channel capacity.

Note: No expansion available for Personal Daq/54.



A Personal Daq and a PDQ module simply plug together for additional channel capacity

Personal Daq and Expansion System Channel Capacities			
Product or System	Volts/TC Inputs*	Digital I/O	Freq/Pulse Inputs
Personal Daq/54	5 DE, 10 SE	—	—
Personal Daq/55	5 DE, 10 SE	8	2
Personal Daq/56	10 DE, 20 SE	16	4
PDQ1 Expansion Module	10 DE, 20 SE	16	—
PDQ2 Expansion Module	20 DE, 40 SE	—	—
Personal Daq/55 + PDQ1	15 DE, 30 SE	24	2
Personal Daq/55 + PDQ2	25 DE, 50 SE	8	2
Personal Daq/56 + PDQ1	20 DE, 40 SE	32	4
Personal Daq/56 + PDQ2	30 DE, 60 SE	16	4

* TC inputs are differential only

PDQ10 DIN-rail Mounting Adapter



The PDQ10 allows one Personal Daq or PDQ module to be DIN-rail mounted. The Personal Daq or PDQ module simply snaps into the PDQ10.

PDQ12 USB Extender Cable



Each PDQ12 adds 16 ft. to the length of your USB cable. Since the extender cable cannot provide adequate power, a TR-2U will be required for the Personal Daq/50 Series

Personal Daq/50 Series

Example Systems

Example Systems

As a USB product, the Personal Daq data acquisition system can be located up to five meters (16.4 feet) from the PC, allowing it to reside close to the point of measurement for improved accuracy and reduced noise. If USB hubs or USB-powered extension cables are used as repeaters between USB cable segments, the Personal Daq can be located up to 30 meters (98.4 feet) from the PC.

Direct Connection to Computer USB Port(s)

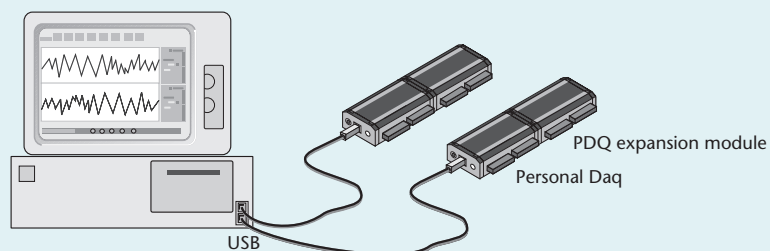

Two Personal Daqs (with optional PDQ modules) are connected by cable to each of the computer's USB ports, requiring no external power source

Connection to Powered USB-Hub

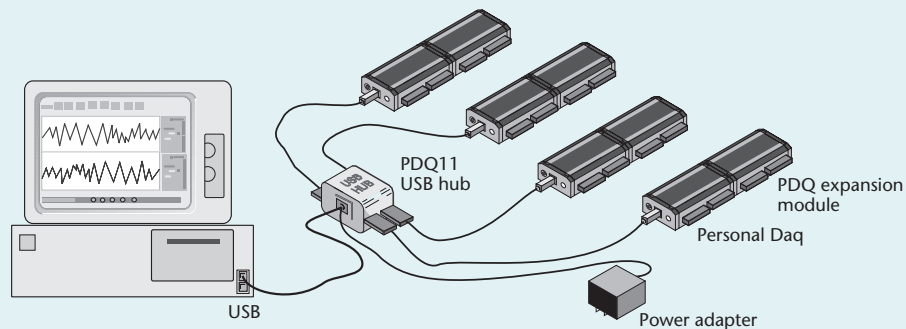

Four Personal Daqs (with optional PDQ modules) are connected to ports of a USB hub, requiring an external power source

Personal DaqView

Out-of-the-Box Software

Personal DaqView, IOtech's included *Out-of-the-Box* graphical data acquisition software, is an easy-to-use yet powerful application. It allows users to configure a test, and display or record data within

minutes, without programming. Together with included PostView post-acquisition viewer software, Personal DaqView offers the most functionality of any included software of its kind.

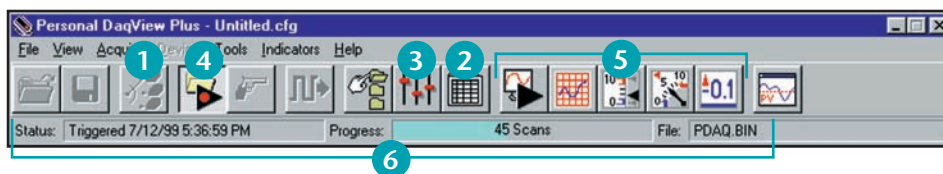

Personal DaqView lets the user:

- 1 Select one of any Personal Daqs connected to the system
- 2 Set up, configure and display analog, frequency, counter, and digital I/O channels in real time
- 3 Easily and quickly configure acquisition parameters such as trigger events, stop events, and acquisition scan rates
- 4 Acquire analog, frequency, and digital I/O channels to disk in real time
- 5 View real-time analog, frequency, and digital I/O using extensive charting and metering displays
- 6 View acquisition status at a glance, including triggered time/date, acquisition progress, as well as acquisition destination file

Physical Channel	User Label	On	Reading	Range	Units	Single-ended/Differential	Measurement Duration	Scale	Offset
PD1_A01	PD1_A01	On	79.472	Type J	°F	Differential	610 ms	1.8	32.0
PD1_A02	PD1_A02	On	72.997	Type J	°F	Differential	610 ms	1.8	32.0
PD1_A03L	PD1_A03L	On	0.0003470	-1.25 to 1.25	V	Single-ended	110 ms	1.0	0.0
PD1_A03H	PD1_A03H	On	-0.00922	-1.25 to 1.25	V	Single-ended	12.5 ms	1.0	0.0
PD1_A04L	PD1_A04L	On	81.785	Type K	°F	Single-ended	610 ms	1.8	32.0
PD1_A04H	PD1_A04H	Off		-5.00 to 5.00	V	Single-ended	12.5 ms	1.0	0.0
PD1_A05	PD1_A05	On	79.929	Type T	°F	Differential	610 ms	1.8	32.0
PD1_A06	PD1_A06	On	88.111	Type K	°F	Differential	610 ms	1.8	32.0
PD1_A07L	PD1_A07L	On	0.01799	-2.50 to 2.50	V	Single-ended	12.5 ms	1.0	0.0
PD1_A07H	PD1_A07H	On	0.00561	-2.00 to 2.00	V	Single-ended	12.5 ms	1.0	0.0
PD1_A08L	PD1_A08L	On	0.01837	-0.6250 to 0.6250	V	Single-ended	12.5 ms	1.0	0.0
PD1_A08H	PD1_A08H	Off		-0.3120 to 0.3120	V	Single-ended	40 ms	1.0	0.0
PD1_A09L	PD1_A09L	On	0.022568	-0.3120 to 0.3120	V	Single-ended	12.5 ms	1.0	0.0
PD1_A09H	PD1_A09H	On	-0.000567	-0.3120 to 0.3120	V	Single-ended	12.5 ms	1.0	0.0

The Analog Input screen allows the user to:

- 1 Easily configure analog input channels such as voltage and temperature measurements
- 2 View channels through both a physical channel description or a user-defined channel description
- 3 Select the minimum measurement duration for a channel on a per-channel basis
- 4 Display real-time readings of active or enabled channels
- 5 Apply scale and offset for real-time $mX+b$ operation
- 6 Have the spreadsheet automatically "grow" as more channels are added to the system

Custom Real-Time Displays

Personal DaqView allows the creation of customized real-time displays using built-in display options, including digital, dial meter, bar graph, and strip chart displays. No programming is required — simply point, click, and drag desired display options to create a custom screen.

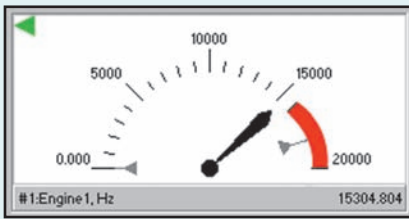

Dial Meter

Personal DaqView allows up to 32 channels to be shown in a dial display format. Each dial indicates instantaneous levels, as well as peak hold and trends.

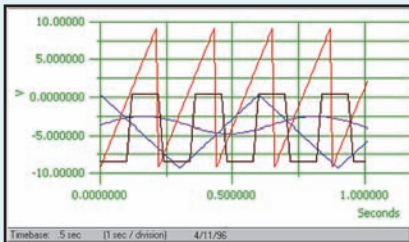

Strip Chart

Display up to 16 smooth-scrolling strip charts of data, all of which scroll at the same rate, and define a full-scale range for each individual channel, as well as adjust the scroll rate to 14 different speeds.

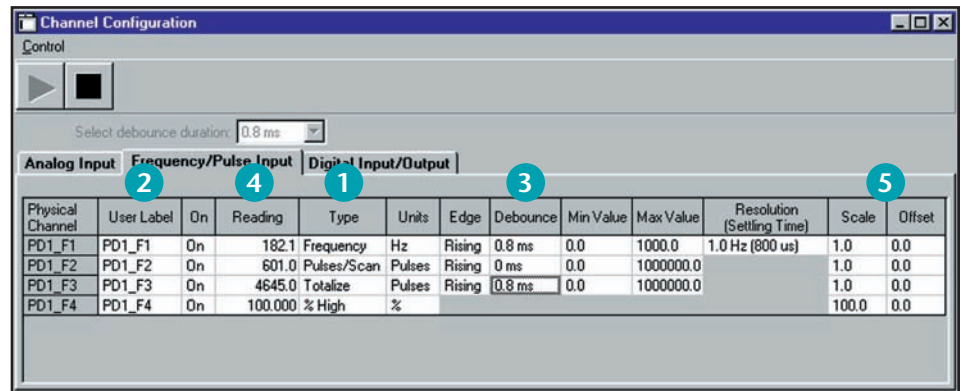

The Frequency/Pulse Input screen allows the user to:

- 1 Easily configure counter channels as frequency, pulse counting, totalized, or duty cycle inputs
- 2 View channels through both a physical channel description or a user-defined channel description
- 3 Set counter input signal debounce, input frequency range, and counter edge sensitivity on a per-channel basis
- 4 Display active or enabled frequency/counter channels in real time
- 5 Apply scale and offset values for real-time $mX+b$ operation

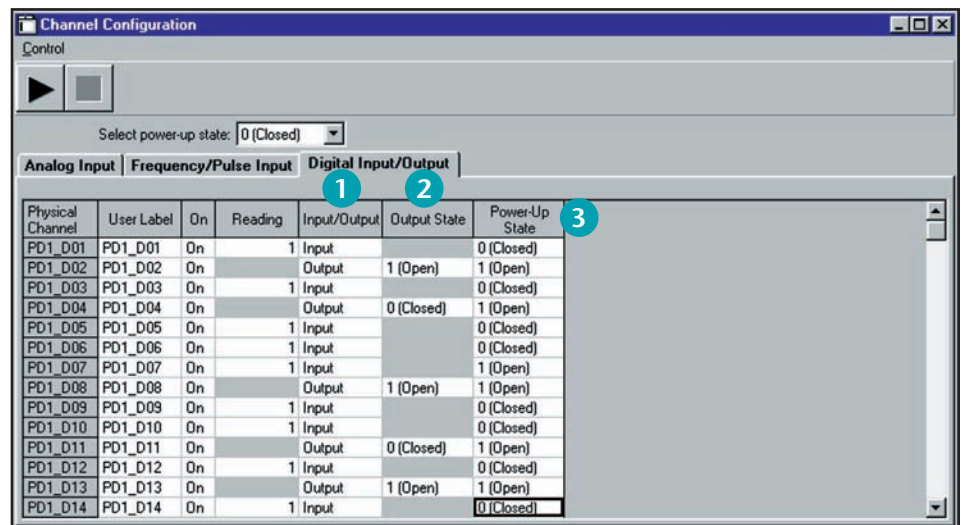

The Digital Input/Output screen allows the user to:

- 1 Read the current state of all digital input channels
- 2 Manually set the state of each digital output channel
- 3 Set the default power-up state for each digital output channel

Personal DaqView

Out-of-the-Box Software

Chart

Personal DaqView software provides advanced charting capabilities, including multiple traces per chart, multiple chart groups, and support for up to 100 Personal Daq devices attached to one PC.

- Allows display groups to be created for customized viewing
- Supports up to 100 Personal Daq devices

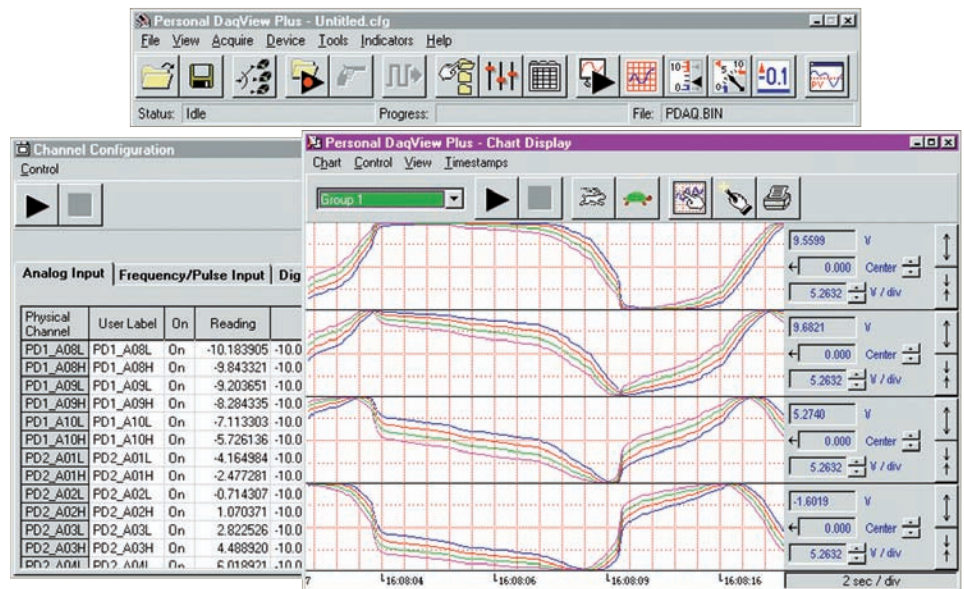

Personal DaqView provides display of multiple channels in one chart

XL Integration

XL integration allows Personal DaqView to execute seamlessly from within Microsoft® Excel's tool palette. Acquired measurements are inserted directly into an Excel® spreadsheet in real time.

- Allows formula creation on acquired data
- Provides control of acquisition from spreadsheet

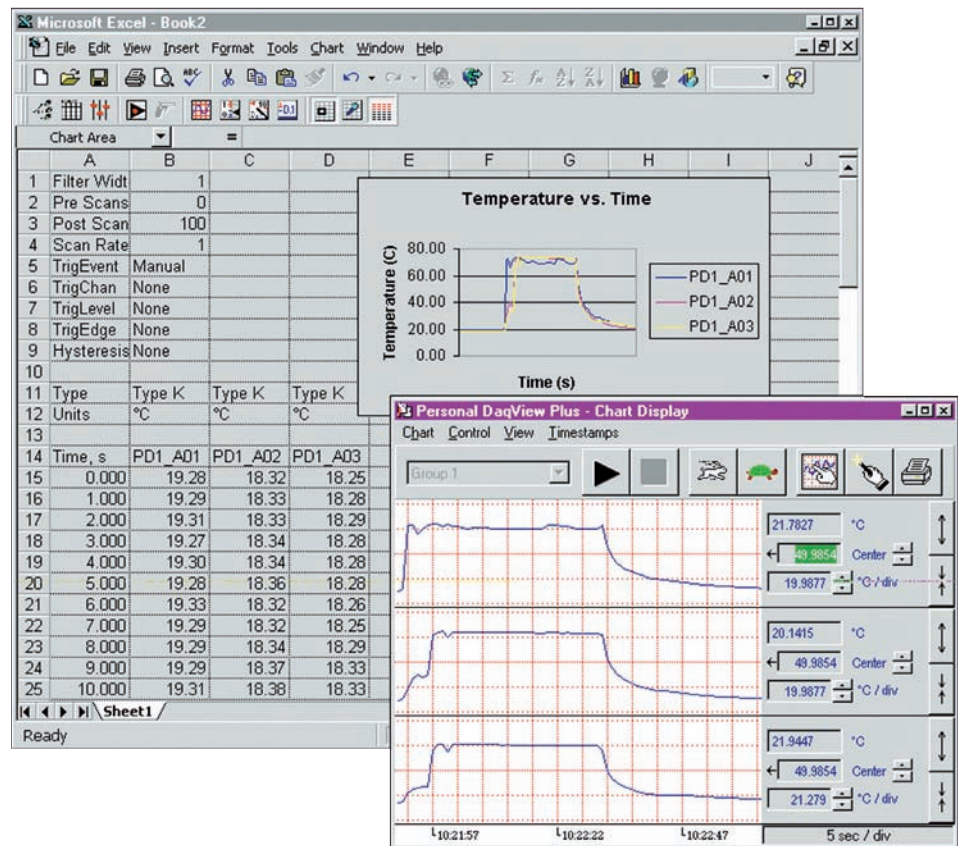

Personal DaqView allows display of collected data with Excel and software package charts

Personal Daq/50 Series

Specifications

Personal Daq Speed vs. Resolution														
Speed Designation	Measurement Duration (per channel)	Maximum Aggregate Rate*											Resolution	
		Volts						Thermocouple						
		1 channel		10 channels		30 channels		1 channel		10 channels		30 channels		
		scans/sec	sec/scan	scans/sec	sec/scan	scans/sec	sec/scan	scans/sec	sec/scan	scans/sec	sec/scan	scans/sec		sec/scan
Slowest, 50/60 Hz rejection	610 ms	1.6500	0.6061	0.1650	6.0606	0.0550	18.1818	1.5800	0.6329	0.1640	6.0976	0.0547	18.2815	22
Slow, 50 Hz rejection	370 ms	2.7100	0.3690	0.2720	3.6765	0.0908	11.0132	2.5400	0.3937	0.2690	3.7175	0.0900	11.1111	22
Slow, 60 Hz rejection	310 ms	3.2400	0.3086	0.3260	3.0675	0.1086	9.2081	2.9900	0.3344	0.3200	3.1250	0.1074	9.3110	22
Medium, 50 Hz rejection	130 ms	7.7500	0.1290	0.7860	1.2723	0.2623	3.8124	6.4900	0.1541	0.7570	1.3210	0.2558	3.9093	21
Medium, 60 Hz rejection	110 ms	9.1700	0.1091	0.9330	1.0718	0.3113	3.2123	7.4600	0.1340	0.8920	1.1211	0.3022	3.3091	21
Medium	40 ms	25.6400	0.0390	2.6900	0.3717	0.8993	1.1120	15.6300	0.0640	2.3800	0.4202	0.8271	1.2090	19
Fast	20 ms	47.6200	0.0210	5.3500	0.1869	1.7953	0.5570	22.2200	0.0450	4.2400	0.2358	1.5291	0.6540	17
Fastest available	12.5 ms	66.6700	0.0150	7.8700	0.1271	2.6525	0.3770	25.6400	0.0390	5.6800	0.1761	2.1097	0.4740	15

* Continuous calibration disabled

Specifications

General

Note: No expansion available for Personal Daq/54.

Isolation: 500V from PC

Power Requirements: Powered from USB, or from an optional external +6 to +16 VDC when PC cannot provide adequate power

Environment: 0° to 50°C, 0 to 95% RH, non-condensing; relatively still air environment recommended for thermocouple measurements

AC Common Mode Rejection

Personal Daq/54: >100 dB @ 50/60 Hz

Personal Daq/55, /56: >120 dB @ 50/60 Hz

Channel-to-Channel Crosstalk: <-110 dB (DC to 100 Hz; up to 10k Ohm source resistance)

Accuracy: 0.02% of reading, +0.004% of range (exclusive of noise)

Input Offset Voltage

Personal Daq/54: <30 µV

Personal Daq/55, /56: <20 µV

Input Resistance: 10M Ohm (SE), 20M Ohm (DE)

Cold-Junction Accuracy

Personal Daq/54: ±0.7°C (15° to 35°C)

Personal Daq/55, /56: ±0.5°C (15° to 35°C)

Dimensions: 182 mm W x 92 mm D x 45 mm H (7.1" x 3.6" x 1.6")

Input Voltage Ranges	
Differential	Single-Ended
-20V to +20V	-10V to +20V
-10V to +10V	-10V to +10V
-5V to +5V	-5V to +5V
-4V to +4V	-4V to +4V
-2.5V to +2.5V	-2.5V to +2.5V
-2V to +2V	-2V to +2V
-1.25V to +1.25V	-1.25V to +1.25V
-1V to +1V	-1V to +1V
-625 mV to +625 mV	-625 mV to +625 mV
-500 mV to +500 mV	-500 mV to +500 mV
-312 mV to +312 mV	-312 mV to +312 mV
-250 mV to +250 mV	-250 mV to +250 mV
-156 mV to +156 mV	-156 mV to +156 mV
-125 mV to +125 mV	-125 mV to +125 mV
-62 mV to +62 mV	-62 mV to +62 mV
-31 mV to +31 mV	-31 mV to +31 mV

Analog Specifications

Each channel is configurable for single-ended or differential, volts, or thermocouple inputs.

Personal Daq/54, /55: 10 single-ended, 5 differential; volts or TC channels

Personal Daq/56: 20 single-ended, 10 differential; volts or TC channels

Input Voltage Range: Software programmable on a per-channel basis

Thermocouple Type: J, K, T, E, R, S, B, N14G, & N28G

Thermocouple Accuracy (°C)^{1,2}

TC Type	Temp Range (°C)	Accuracy (°C)
J	-100 to +700	±1.1
K	-200 to +1200	±1.2
T	-100 to +400	±1.1
E	-100 to +500	±1.0
R	+400 to +1400	±2.5
S	+400 to +1400	±2.6
B	+700 to +1400	±3.3
N	-100 to +700	±1.5

1. Thermocouple accuracy includes cold-junction compensation error of ±0.5°C

2. Assume an acquisition speed of 610 ms per measurement

Over-Voltage Protection: ±45V relative to analog COM

Common Mode Rejection

Personal Daq/54: 100 dB @ 60 Hz

Personal Daq/55, /56: 120 dB @ 60 Hz

Channel-to-Channel Crosstalk: 120 dB (0 to 100 Hz)

Gain Accuracy: 0.01% (after calibration, 15° to 35°C), 5 ppm/°C gain drift

Input Impedance: 10M Ohm (SE), 20M Ohm (DE)

Bias Current: <1 nA (0° to 35°C)

Measurement Speed: Each channel can have a different measurement speed and resolution. Channels can be programmed to be scanned in any order.

Frequency Measurements

(/55 and /56 only)

Personal Daq/55: 2 frequency/pulse input channels

Personal Daq/56: 4 frequency/pulse input channels

Operating Modes: Pulse count, totalize, duty-cycle, and frequency

Frequency Response: DC to 1 MHz

Input Range: ±15V, Schmitt-trigger inputs, <1.3V (low), >3.8V (high)

Pull-Up Resistor: 27k Ohm to +5V for switch or relay sensing

Debouncing: None, 0.8, 3.2, or 13 mSec.

Totalize: Up to 2³² counts/scan

Frequency & Duty-Cycle Resolution: 7 digits. Actual resolution depends on scan rate. At 10 scans/s, resolution is 5 digits (10 ppm); at 1 scan/s, 6 digits (1 ppm).

Digital I/O (/55 and /56 only)

Each I/O line is individually programmable as input or output.

Personal Daq/55: 8 digital I/O lines

Personal Daq/56: 16 digital I/O lines

Each I/O line includes an open-collector driver with a 27k Ohm pull-up resistor to +5V for output, and a Schmitt-trigger input buffer.

Over-Voltage: +20V for up to 1 minute

Input

Voltage Range: 0 to +15V

Thresholds: <1.3V (low), >3.8V (high)

Output

Voltage Range: 0 to +5V with no external pull-up resistor; 0 to +15V with external pull-up

Maximum Sink Current: 150 mA/output continuous, 500 mA output peak (<100 µs), 150 mA total continuous (per bank of 8 outputs)

Output Resistance: 10 Ohms max
Updates: Outputs may be changed arbitrarily at any time under program control

Personal Daq/50 Series

Ordering Information



Ordering Information

Description	Part No.
22-bit data acquisition system including Personal DaqView and PostView software; support for Visual Basic®, C/C++, DASyLab®, and LabVIEW®	Personal Daq/54 Personal Daq/55 Personal Daq/56
Expansion module, with 20 volts/TC inputs and 16 digital I/O	PDQ1
Expansion module, with 40 volts/TC inputs	PDQ2
DIN-rail mounting adapter for Personal Daq	PDQ10
Powered 4-port USB hub with one USB cable	PDQ11
USB-powered extension cable, 16 ft.	PDQ12

Accessories & Cables

Description	Part No.
USB cable, 1 meter	CA-179-1
USB cable, 3 meters	CA-179-3
USB cable, 5 meters	CA-179-5
Terminal block	CN-153-12
External power supply, 90 to 264 VAC; requires additional cable	TR-2U
USA version	CA-1
European version	CA-216

Software

Description	Part No.
Icon-based data acquisition, graphics, control, & analysis with Personal Daq driver	DASyLab

BUY NOW!

For complete product specifications, pricing, and accessory information, call 1-888-714-3272 (U.S. only) or visit iotech.com.