

LTCC Chip Antennas – How to maximize performance

Johanson Technology Inc.

Johanson Technology Inc.
4001 Calle Tecate
Camarillo, CA 93012

URL: <http://johansontechnology.com>

Outline

- Chip Antenna Characteristics
- Antenna Selection Considerations
- Circuit Design Constraints
- Layout Tips

Ultimate Goal → To Maximize Performance

Motivation

- Chip Antenna an efficient means of “connectivity” to modern portable compact electronic devices.
- Miniature portable devices requires small antennas.
- Can be internalized – i.e. “Concealed” within device.

Pros

- Chip antennas are small, cheap and performs well.
- Bulky external “whip” type antennas are thing of the past.

Cons

- Must be accounted for during initial circuit design stage
- Interference, proximity de-tuning & degradation concerns.

LTCC Chip Antennas



Chip Antenna Characteristics -1

- Features Ag radiating element encapsulated in ceramic.
- A quarter-wave ($\lambda / 4$) monopole system.
- Works with GND plane to form dipole system.
- Certain “No-GND” metal-free space necessary.
- Small form factor, thin profile & light weight

Chip Antenna Characteristics - 2

- Omni-directional radiation.
- Linear Polarization.
- Mounting configuration flexibility.
- Frequency range supported: 0.08 GHz thru 10 GHz.
- WiFi, BT, WiMAX, UWB, GSM, CDMA, GPS etc.
- Suitable for Pick & Place.

Antenna Selection Considerations -1

- Size
- Frequency Band
- Bandwidth
- Polarization
- Peak Gain
- Average Gain
- Radiation Pattern requirements

Antenna Selection Considerations -2

- Successful Antenna design means harmonious interaction of the “seven” parameters (next page)
- Additional considerations for diversity systems
 - e.g. MIMO
- Overall performance is always system dependent .

Circuit Design Constraints

1. Size of the Circuit board.
2. Layout of other board components.
3. Complexity of circuit.
4. Proper GND/No-GND dimensions and clearances.
5. “Tuning” Matching Circuitry
6. Shielding
7. Suitable Enclosure (material)

Layout Tips -1

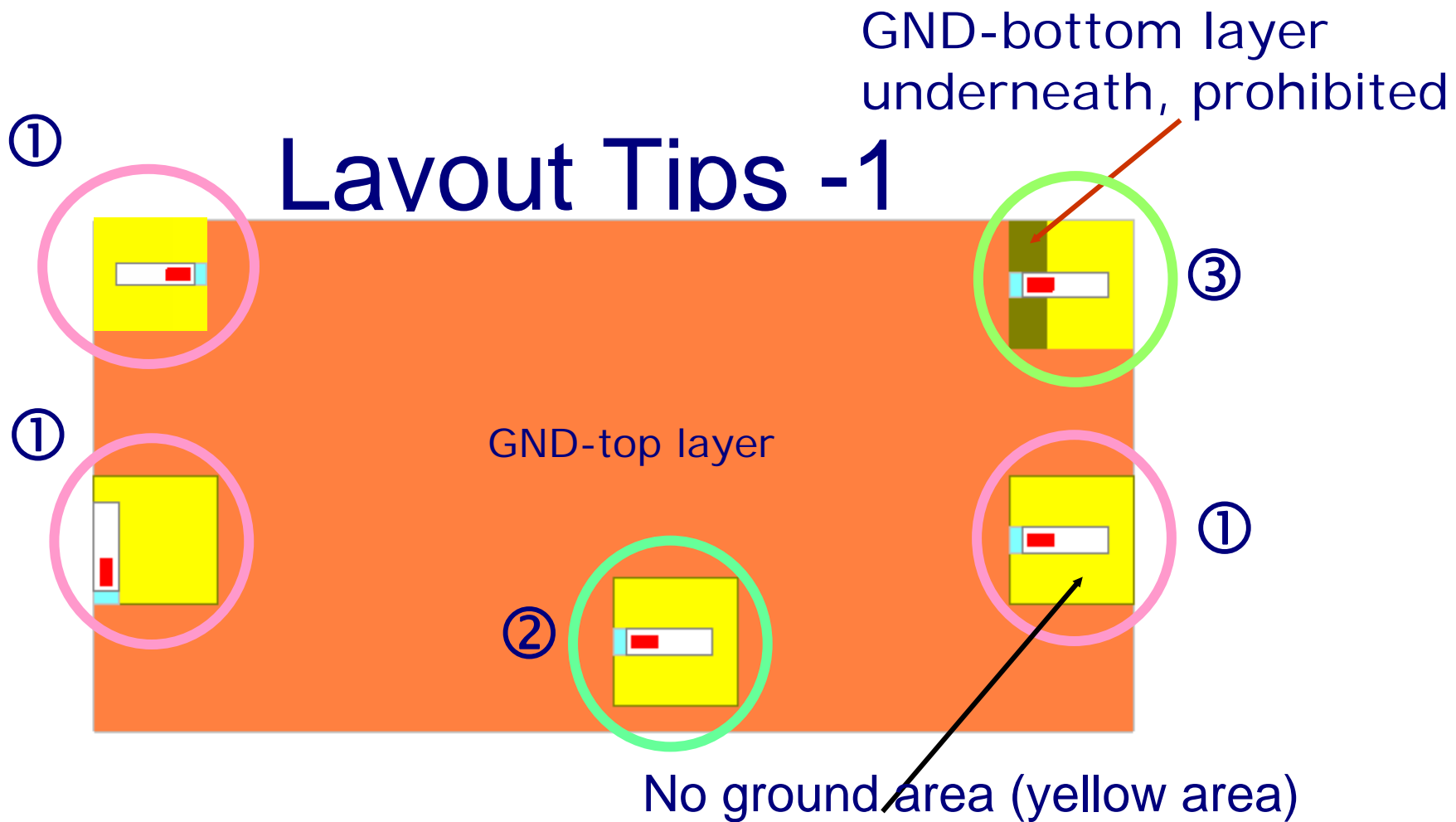

- Good Placements ①
- Bad Placements ② & ③

Layout Tips -2

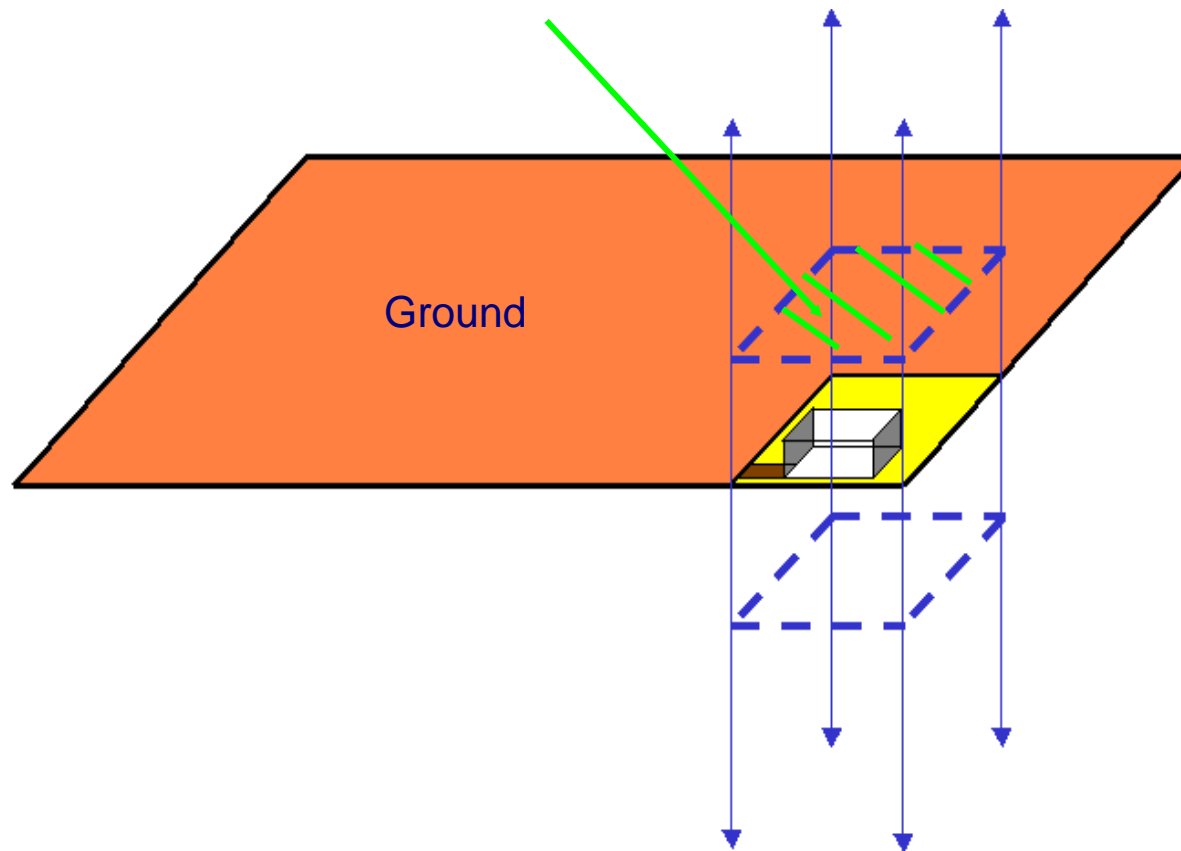

Don't put any metal objects or batteries (if applicable) above or below the yellow region
Keep away any other metals from clearance area.

Layout Tips -3



- Further examples of good antenna placement schemes

Layout Tips -4

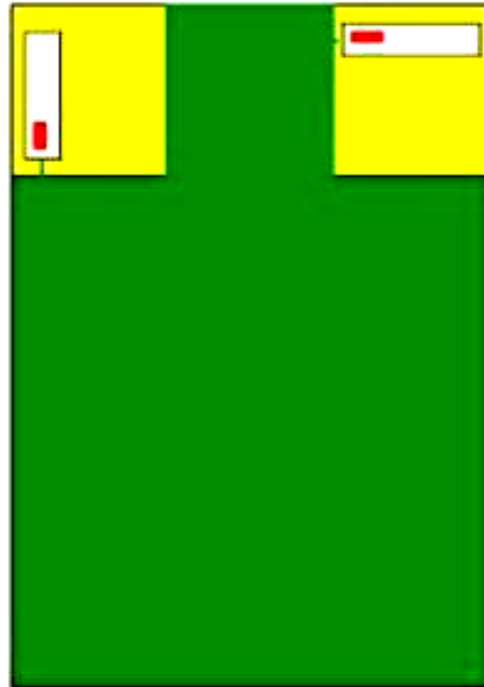
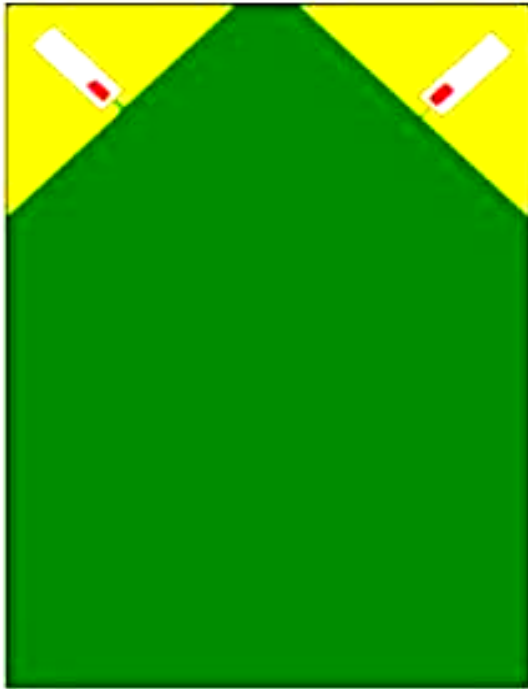

ANT 1 ——— (red line)
ANT 2 ——— (blue line)
Pattern compensation - - - (magenta dashed line)

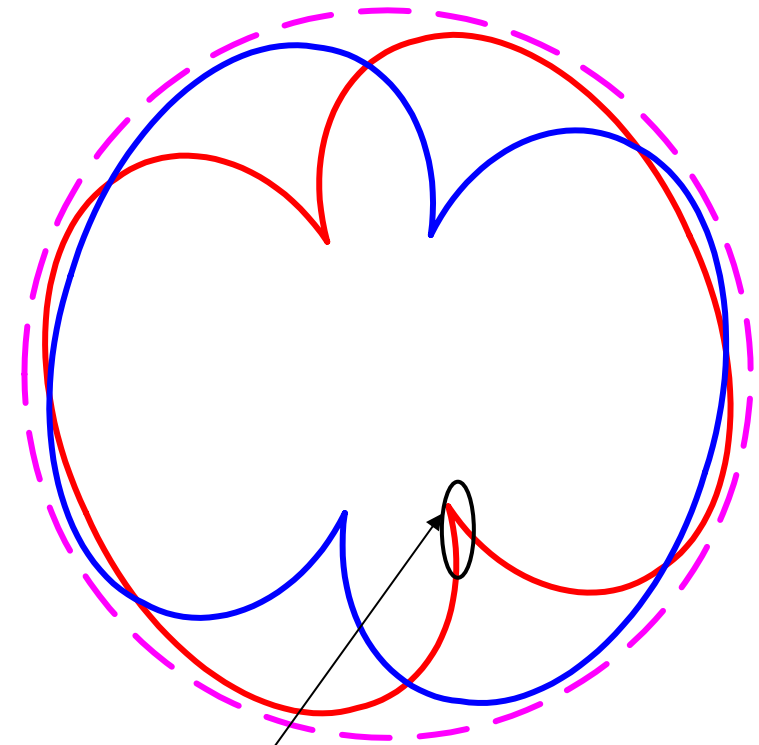

Radiation pattern

“Null”

Elimination/Compensation

- Antenna placement schemes for antenna diversity systems

Antenna Matching -5

A. Antenna Matching Setup

**Test Board
matching example**

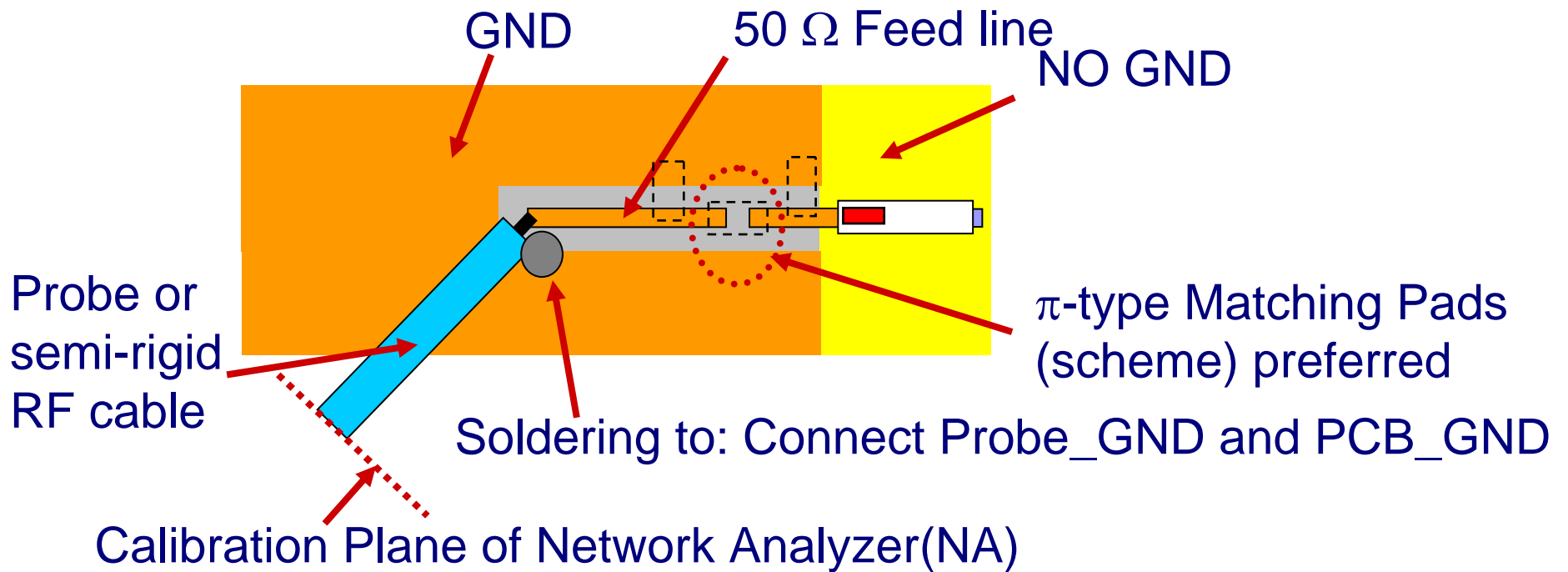

B. Measuring Steps

1. One-port (S11) calibration for N.A. (Network Analyzer)
Open-Short-Load for desired operating bandwidth
2. Mount probe (semi-rigid RF cable for our example) onto PCB and connect to N.A.
3. Measure S11 of test board without antenna or any matching components and save as:
→S11_open →save trace to memory of N.A.
4. Measure S11 of test board with antenna and series 0Ω resistor mounted and save as: →S11_antenna
5. Set N.A. to data/memory mode (S11_antenna/S11_open) and display/save as: →S11_match
6. Match the trace of S11_match to 50Ω
(center of Smith chart at the desired frequency)

1. Probe+Feed Line Smith chart display from 1-4GHz (not-normalized)

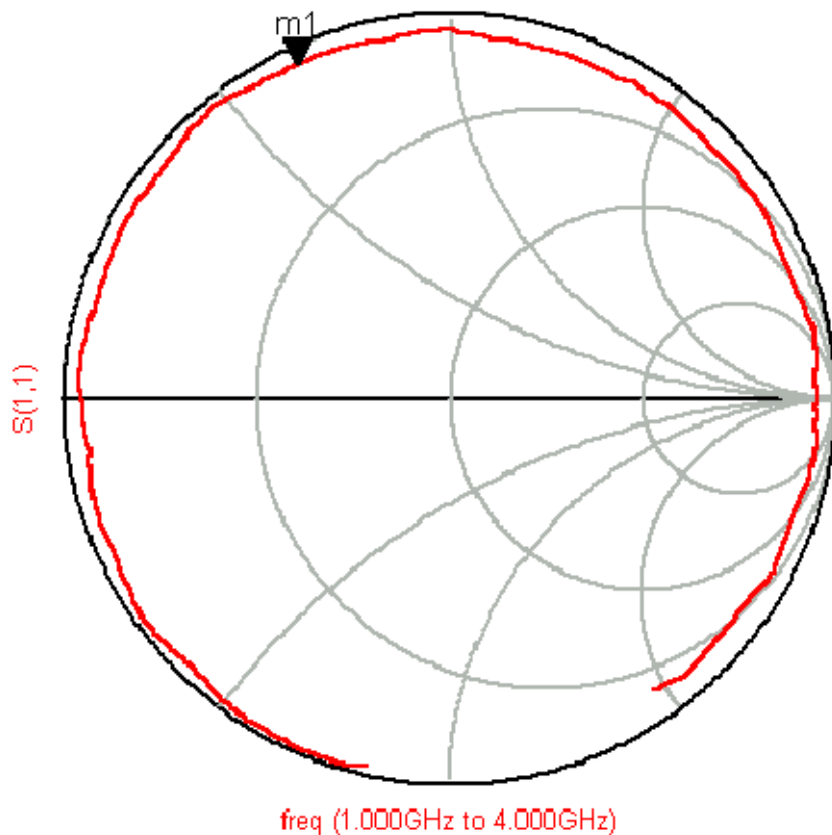

2. Probe+Feed Line (normalized)

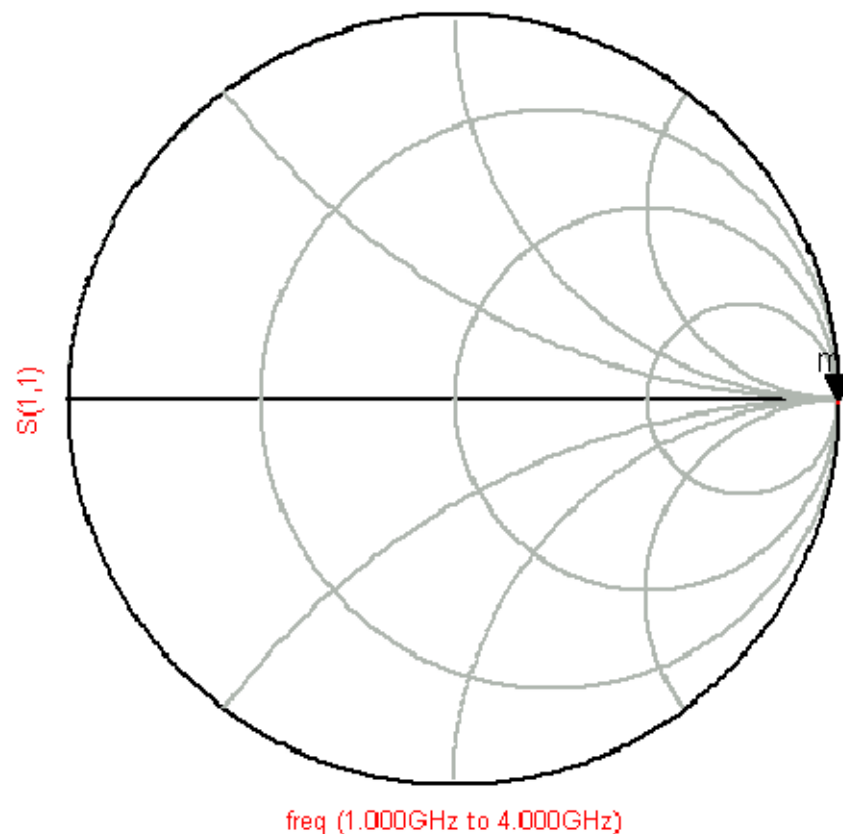

**Test Board
matching example**

1. Probe + Feed Line + Antenna
Smith chart display from 1-4GHz
(not-normalized)

(not normalized)

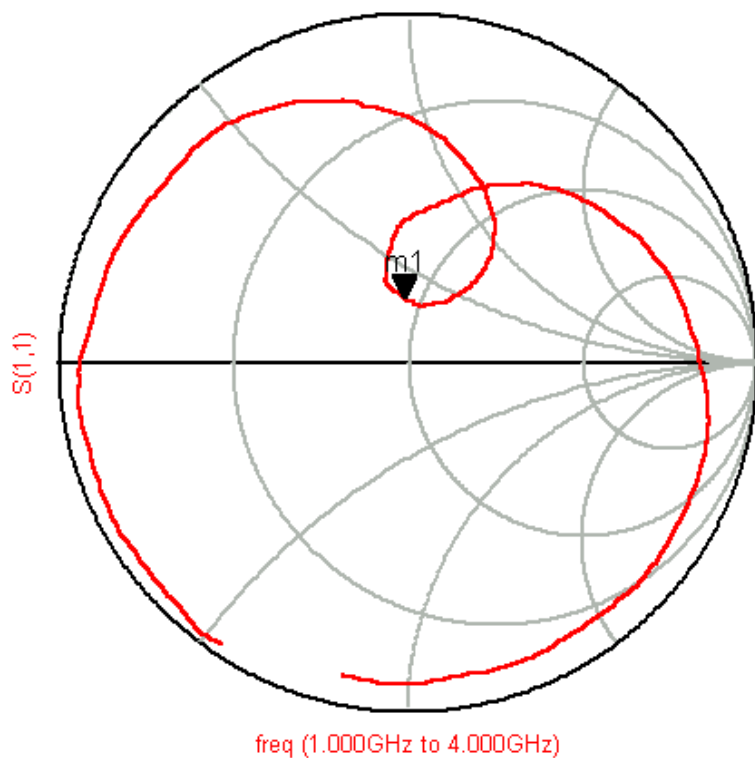

2. Probe + Feed Line + Antenna
(normalized)

(normalized)

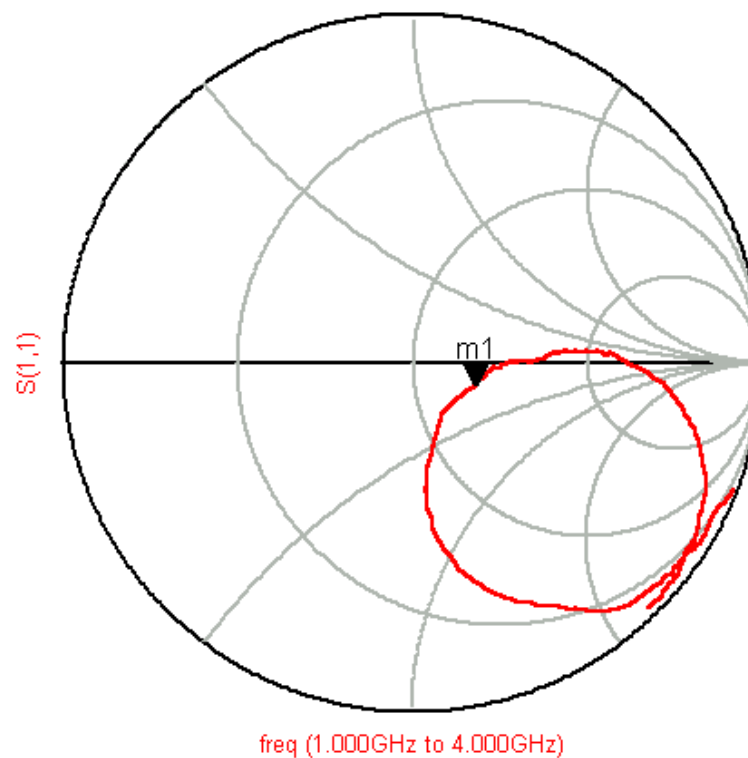

**Test Board
matching example**

Step 1 in matching:

Ant + shunt 3.9nH (normalized)

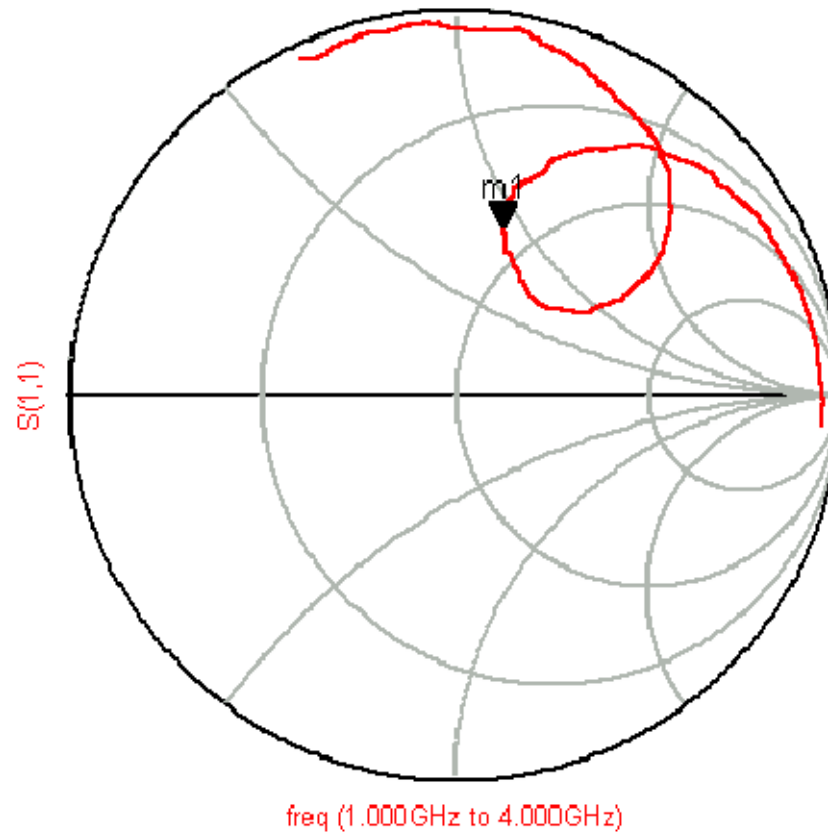

**Test Board
matching example**

Step 2 in matching:

Ant + shunt 3.9nH + series 1.5pF (normalized)

Test Board matching example

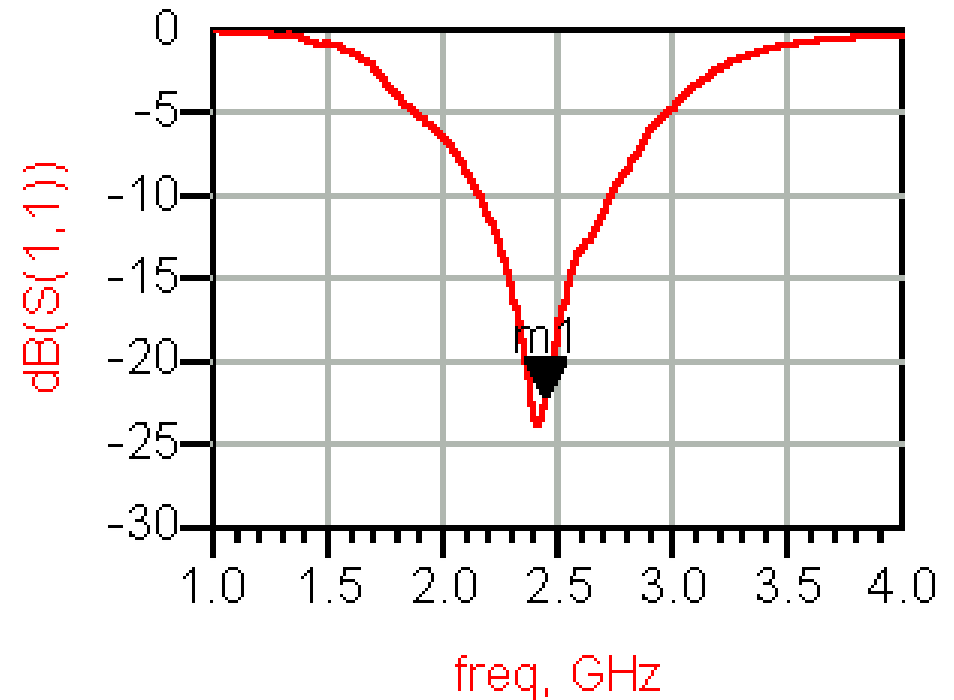
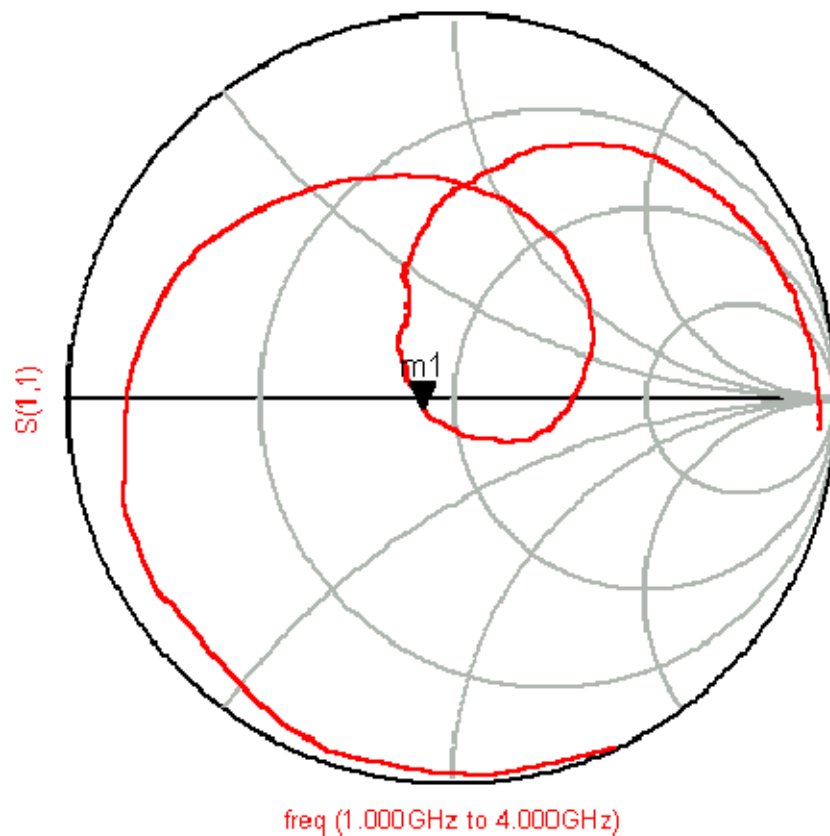

Matched Return Loss chart

Matched Antenna Example

Test Board

EVB p/n:
2450AT45A100-EB1SMA

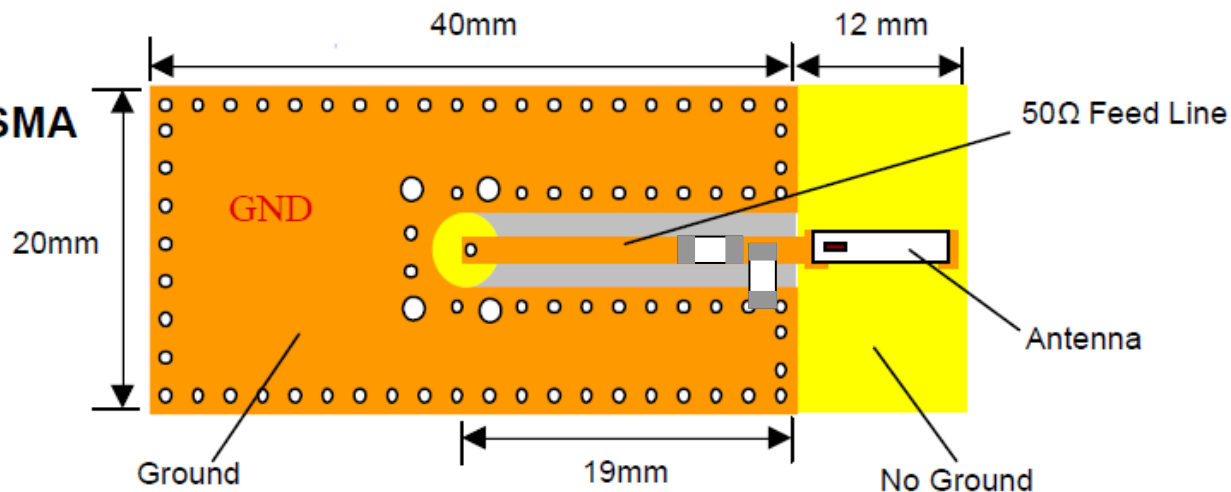

Return Loss

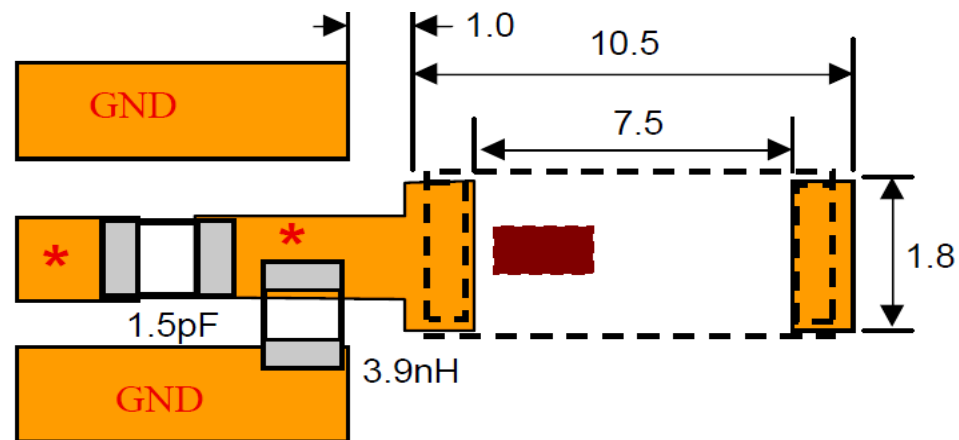

b) With Matching Circuit* (wide bandwidth)

* matching circuit and component values will depend on PCB layout, thickness, material, etc.

General Specifications

Part Number	2450AT45A100
Frequency Range	2400 - 2500 Mhz
Peak Gain	3.0 dBi typ. (XZ-V)
Average Gain	1.0 dBi typ. (XZ-V)
Return Loss	9.5 dB min.

JTI P/N for Matching Circuit:
Cap (1.5pF): 500R07S1R5BV4T
Inductor (3.9nH): L-07C3N9SV6T

Conclusion – How to design

- 1st – Determine the antenna location and space available on board
- 2nd – Select the most appropriate antenna model
- 3rd - Implement antenna in conformance with design rules
- 4th – Match antenna to your system